

IN74HC323A

8-Bit Bidirectional Universal Shift Register with Parallel I/O
High-Performance Silicon-Gate CMOS

The IN74HC323A is identical in pinout to the LS/ALS323. The device inputs are compatible with standard CMOS outputs; with pullup resistors, they are compatible with LS/ALSTTL outputs.

The IN74HC323A features a multiplexed parallel input/output data port to active full 8-bit handling in a 20 pin package. Due to the large output drive capability and the 3-state feature, this device is ideally suited for interface with bus lines in a bus-oriented system.

Two Mode-Select inputs and two Output Enable inputs are used to choose the mode of operation as listed in the Function Table. Synchronous parallel loading is accomplished by taking both Mode-Select lines, S₁ and S₂, high. This places the outputs in the high-impedance state, which permits data applied to the data port to be clocked into the register. Reading out of the register can be accomplished when the outputs are enabled. The active-low synchronous Reset overrides all other inputs.

- Outputs Directly Interface to CMOS, NMOS, and TTL
- Operating Voltage Range: 2.0 to 6.0 V
- Low Input Current: 1.0 μA
- High Noise Immunity Characteristic of CMOS Devices

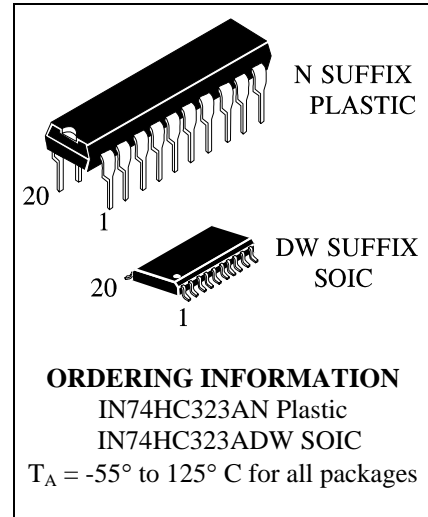

LOGIC DIAGRAM

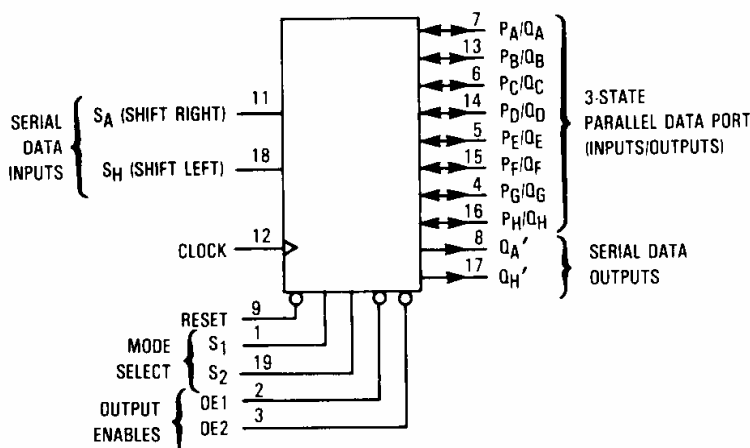

PIN 20 = V_{CC}
 PIN 10 = GND

PIN ASSIGNMENT

S1	1	20	V _{CC}
OE1	2	19	S2
OE2	3	18	S _H
PG/QG	4	17	QH'
PE/QE	5	16	PH/QH
PC/QC	6	15	PF/QF
PA/QA	7	14	PD/QD
QA'	8	13	PB/QB
RESET	9	12	CLOCK
GND	10	11	SA

MAXIMUM RATINGS*

Symbol	Parameter	Value	Unit
V_{CC}	DC Supply Voltage (Referenced to GND)	-0.5 to +7.0	V
V_{IN}	DC Input Voltage (Referenced to GND)	-1.5 to $V_{CC} + 1.5$	V
V_{OUT}	DC Output Voltage (Referenced to GND)	-0.5 to $V_{CC} + 0.5$	V
I_{IN}	DC Input Current, per Pin	± 20	mA
I_{OUT}	DC Output Current, per Pin	± 35	mA
I_{CC}	DC Supply Current, V_{CC} and GND Pins	± 75	mA
P_D	Power Dissipation in Still Air, Plastic DIP+ SOIC Package+	750 500	mW
T_{stg}	Storage Temperature	-65 to +150	$^{\circ}C$
T_L	Lead Temperature, 1 mm from Case for 10 Seconds (Plastic DIP or SOIC Package)	260	$^{\circ}C$

*Maximum Ratings are those values beyond which damage to the device may occur. Functional operation should be restricted to the Recommended Operating Conditions.

+Derating - Plastic DIP: - 10 mW/ $^{\circ}C$ from 65 $^{\circ}$ to 125 $^{\circ}C$

SOIC Package: - 7 mW/ $^{\circ}C$ from 65 $^{\circ}$ to 125 $^{\circ}C$

RECOMMENDED OPERATING CONDITIONS

Symbol	Parameter	Min	Max	Unit
V_{CC}	DC Supply Voltage (Referenced to GND)	2.0	6.0	V
V_{IN}, V_{OUT}	DC Input Voltage, Output Voltage (Referenced to GND)	0	V_{CC}	V
T_A	Operating Temperature, All Package Types	-55	+125	$^{\circ}C$
t_r, t_f	Input Rise and Fall Time (Figure 1)			ns
	$V_{CC} = 2.0$ V	0	1000	
	$V_{CC} = 4.5$ V	0	500	
	$V_{CC} = 6.0$ V	0	400	

This device contains protection circuitry to guard against damage due to high static voltages or electric fields. However, precautions must be taken to avoid applications of any voltage higher than maximum rated voltages to this high-impedance circuit. For proper operation, V_{IN} and V_{OUT} should be constrained to the range $GND \leq (V_{IN} \text{ or } V_{OUT}) \leq V_{CC}$.

Unused inputs must always be tied to an appropriate logic voltage level (e.g., either GND or V_{CC}). Unused outputs must be left open. I/O pins must be connected to a properly terminated line or bus.

DC ELECTRICAL CHARACTERISTICS (Voltages Referenced to GND)

Symbol	Parameter	Test Conditions	V _{CC} V	Guaranteed Limit			Unit
				25 °C to -55°C	≤85 °C	≤125 °C	
V _{IH}	Minimum High-Level Input Voltage	V _{OUT} =0.1 V or V _{CC} -0.1 V I _{OUT} ≤ 20 μA	2.0	1.5	1.5	1.5	V
			4.5	3.15	3.15	3.15	
			6.0	4.2	4.2	4.2	
V _{IL}	Maximum Low - Level Input Voltage	V _{OUT} =0.1 V or V _{CC} -0.1 V I _{OUT} ≤ 20 μA	2.0	0.3	0.3	0.3	V
			4.5	0.9	0.9	0.9	
			6.0	1.2	1.2	1.2	
V _{OH}	Minimum High-Level Output Voltage	V _{IN} =V _{IH} or V _{IL} I _{OUT} ≤ 20 μA	2.0	1.9	1.9	1.9	V
			4.5	4.4	4.4	4.4	
			6.0	5.9	5.9	5.9	
		V _{IN} =V _{IH} or V _{IL} I _{OUT} ≤ 6.0 mA (P/Q) I _{OUT} ≤ 7.8 mA (P/Q)	4.5	3.98	3.84	3.7	
			6.0	5.48	5.34	5.2	
			V _{IN} =V _{IH} or V _{IL} I _{OUT} ≤ 4.0 mA (Q') I _{OUT} ≤ 5.2 mA (Q')	4.5	3.98	3.84	
6.0	5.48	5.34		5.2			
V _{OL}	Maximum Low-Level Output Voltage	V _{IN} = V _{IL} or V _{IH} I _{OUT} ≤ 20 μA		2.0	0.1	0.1	0.1
			4.5	0.1	0.1	0.1	
			6.0	0.1	0.1	0.1	
		V _{IN} =V _{IH} or V _{IL} I _{OUT} ≤ 6.0 mA (P/Q) I _{OUT} ≤ 7.8 mA (P/Q)	4.5	0.26	0.33	0.4	
			6.0	0.26	0.33	0.4	
			V _{IN} =V _{IH} or V _{IL} I _{OUT} ≤ 4.0 mA (Q') I _{OUT} ≤ 5.2 mA (Q')	4.5	0.26	0.33	0.4
6.0	0.26	0.33		0.4			
I _{IN}	Maximum Input Leakage Current	V _{IN} =V _{CC} or GND		6.0	±0.1	±1.0	±1.0
I _{OZ}	Maximum Three-State Leakage Current (Q _A thru Q _H)	Output in High-Impedance State V _{IN} = V _{IL} or V _{IH} V _{OUT} =V _{CC} or GND	6.0	±0.5	±5.0	±10	μA
I _{CC}	Maximum Quiescent Supply Current (per Package)	V _{IN} =V _{CC} or GND I _{OUT} =0μA	6.0	8.0	80	160	μA









AC ELECTRICAL CHARACTERISTICS ($C_L=50\text{pF}$, Input $t_r=t_f=6.0\text{ ns}$)

Symbol	Parameter	V _{CC} V	Guaranteed Limit			Unit
			25 °C to -55°C	≤85 °C	≤125 °C	
f _{max}	Maximum Clock Frequency (50% Duty Cycle) (Figures 1 and 5)	2.0	5.0	4.0	3.4	MHz
		4.5	25	20	17	
		6.0	29	24	20	
t _{PLH} , t _{PHL}	Maximum Propagation Delay, Clock to Q _A ' or Q _H ' (Figures 1 and 5)	2.0	170	215	255	ns
		4.5	34	43	51	
		6.0	29	37	43	
t _{PLH} , t _{PHL}	Maximum Propagation Delay, Clock to Q _A or Q _H (Figures 1 and 5)	2.0	160	200	240	ns
		4.5	32	40	48	
		6.0	27	34	41	
t _{P LZ} , t _{P HZ}	Maximum Propagation Delay , OE1, OE2, S1, or S2 to Q _A thru Q _H (Figures 3 and 6)	2.0	150	190	225	ns
		4.5	30	38	45	
		6.0	26	33	38	
t _{P ZL} , t _{P ZH}	Maximum Propagation Delay , OE1, OE2, S1, or S2 to Q _A thru Q _H (Figures 3 and 6)	2.0	150	190	225	ns
		4.5	30	38	45	
		6.0	26	33	38	
t _{TLH} , t _{THL}	Maximum Output Transition Time, Q _A thru Q _H (Figures 1 and 5)	2.0	60	75	90	ns
		4.5	12	15	18	
		6.0	10	13	15	
t _{TLH} , t _{THL}	Maximum Output Transition Time, Q _A ' or Q _H ' (Figures 1 and 5)	2.0	75	95	110	ns
		4.5	15	19	22	
		6.0	13	16	19	
C _{IN}	Maximum Input Capacitance	-	10	10	10	pF
C _{OUT}	Maximum Three-State Output Capacitance (Output in High-Impedance State), Q _A thru Q _H	-	15	15	15	pF
C _{PD}	Power Dissipation Capacitance (Per Package), Outputs Enable	Typical @25°C, V _{CC} =5.0 V				pF
	Used to determine the no-load dynamic power consumption: $P_D=C_{PD}V_{CC}^2f+I_{CC}V_{CC}$	240				

TIMING REQUIREMENTS ($C_L=50\text{pF}$, Input $t_r=t_f=6.0\text{ ns}$)

Symbol	Parameter	V _{CC} V	Guaranteed Limit			Unit
			25 °C to-55°C	≤85°C	≤125°C	
t _{su}	Minimum Setup Time, Mode Select S1 or S2 to Clock (Figure 4)	2.0	100	125	150	ns
		4.5	20	25	30	
		6.0	17	21	26	
t _{su}	Minimum Setup Time, Data Inputs S _A , S _H , P _A thru P _H to Clock (Figure 4)	2.0	100	125	150	ns
		4.5	20	25	30	
		6.0	17	21	26	
t _h	Minimum Hold Time, Clock to Mode Select S1 or S2 (Figure 4)	2.0	120	150	180	ns
		4.5	24	30	36	
		6.0	20	26	31	
t _h	Minimum Hold Time, Clock to Data Inputs, S _A , S _H , P _A thru P _H (Figure 4)	2.0	5	5	5	ns
		4.5	5	5	5	
		6.0	5	5	5	
t _w	Minimum Pulse Width, Clock (Figure 1)	2.0	80	100	120	ns
		4.5	16	20	24	
		6.0	14	17	20	
t _w	Minimum Pulse Width, Reset (Figure 2)	2.0	80	100	120	ns
		4.5	16	20	24	
		6.0	14	17	20	
t _r , t _f	Maximum Input Rise and Fall Times (Figure 1)	2.0	1000	1000	1000	ns
		4.5	500	500	500	
		6.0	400	400	400	

FUNCTION TABLE

Mode	Inputs								Response									
	Reset	Mode Select		Output Enables		Clock	Serial Inputs		P _A / Q _A	P _B / Q _B	P _C / Q _C	P _D / Q _D	P _E / Q _E	P _F / Q _F	P _G / Q _G	P _H / Q _H	Q _A '	Q _H '
		S ₂	S ₁	OE1 [↑]	OE2 [↑]		D _A	D _H										
Reset	L	X	L	L	L		X	X	L	L	L	L	L	L	L	L	L	L
	L	L	X	L	L		X	X	L	L	L	L	L	L	L	L	L	L
	L	H	H	X	X	X	X	X	Q _A through Q _H =Z								L	L
Shift Right	H	L	H	H	X		D	X	Shift Right: Q _A through Q _H =Z; D _A →F _A ; F _A →F _B ; etc								D	Q _G
	H	L	H	X	H		D	X	Shift Right: Q _A through Q _H =Z; D _A →F _A ; F _A →F _B ; etc								D	Q _G
	H	L	H	L	L		D	X	Shift Right: D _A →F _A =Q _A ; F _A →F _B =Q _B ; etc								D	Q _G
Shift Left	H	H	L	H	X		X	D	Shift Left: Q _A through Q _H =Z; D _H →F _H ; F _H →F _G ; etc								Q _B	D
	H	H	L	X	H		X	D	Shift Left: Q _A through Q _H =Z; D _H →F _H ; F _H →F _G ; etc								Q _B	D
	H	H	L	L	L		X	D	Shift Left: D _H →F _H =Q _H ; F _H →F _G =Q _G ; etc								Q _B	D
Parallel Load	H	H	H	X	X		X	X	Parallel Load: P _N →F _N								P _A	P _H
Hold	H	L	L	H	X	X	X	X	Hold: Q _A through Q _H =Z; F _N =F _N								P _A	P _H
	H	L	L	X	H	X	X	X	Hold: Q _A through Q _H =Z; F _N =F _N								P _A	P _H
	H	L	L	L	L	X	X	X	Hold: Q _N =Q _H								P _A	P _H

Z = high impedance

D = data on serial input

F = flip-flop (see Logic Diagram)

[↑] When one or both output controls are high the eight input/output terminals are disabled to the high-impedance state; however, sequential operation or clearing of the register is not affected.

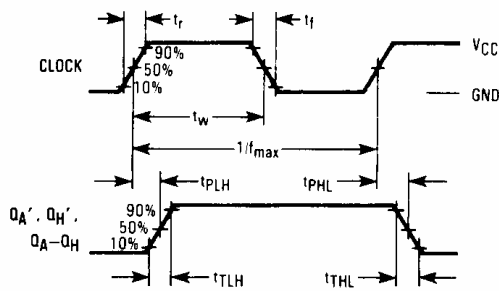

Figure 1. Switching Waveforms

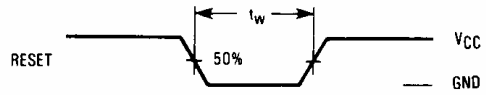

Figure 2. Switching Waveforms

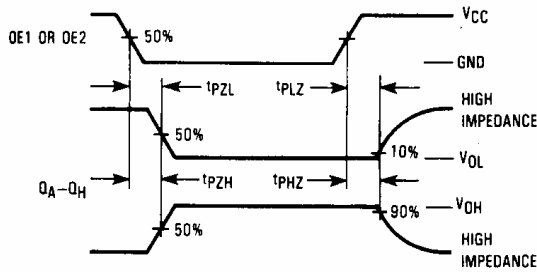

Figure 3a. Switching Waveforms

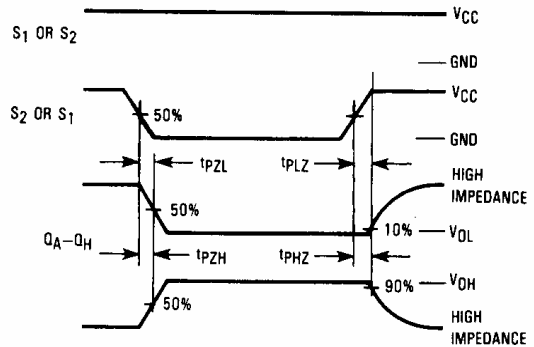

Figure 3b. Switching Waveforms

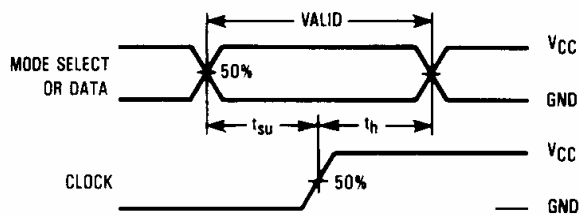
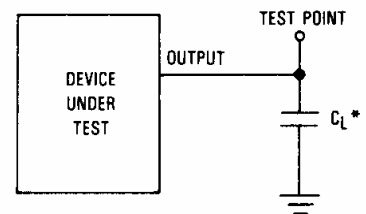
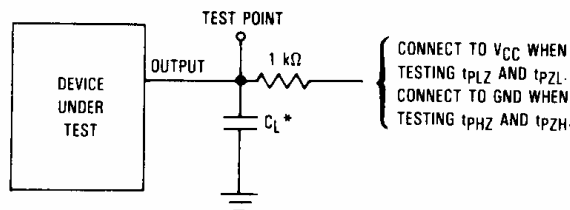

Figure 4. Switching Waveforms



*Includes all probe and jig capacitance.

Figure 5. Test Circuit



*Includes all probe and jig capacitance.

Figure 6. Test Circuit

N SUFFIX PLASTIC DIP
(MS - 001AD)

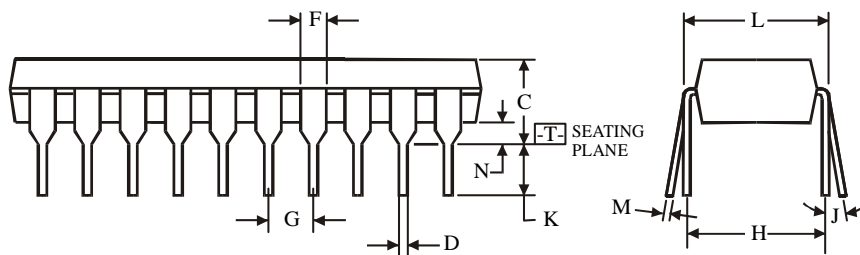
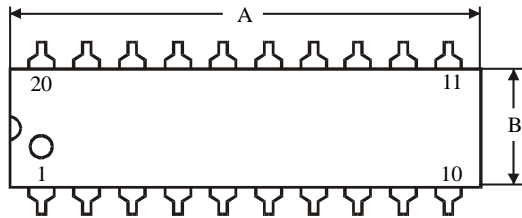
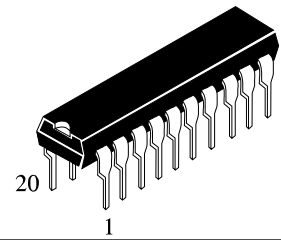

$\oplus 0.25 (0.010) \text{M} \text{ T}$

NOTES:

- Dimensions "A", "B" do not include mold flash or protrusions.
Maximum mold flash or protrusions 0.25 mm (0.010) per side.

Symbol	Dimension, mm	
	MIN	MAX
A	24.89	26.92
B	6.1	7.11
C		5.33
D	0.36	0.56
F	1.14	1.78
G	2.54	
H	7.62	
J	0°	10°
K	2.92	3.81
L	7.62	8.26
M	0.2	0.36
N	0.38	

D SUFFIX SOIC
(MS - 013AC)

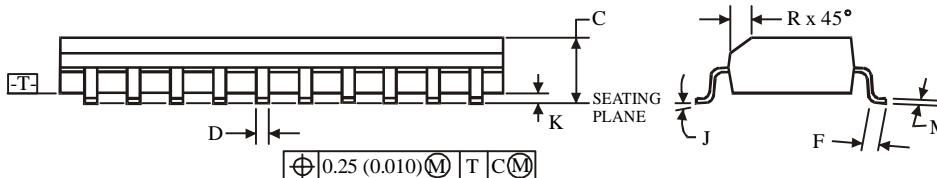
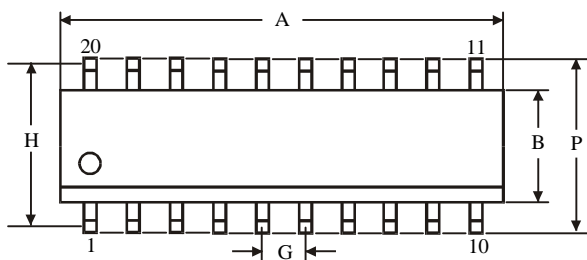
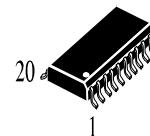

$\oplus 0.25 (0.010) \text{M} \text{ T} \text{ C} \text{ M}$

NOTES:

- Dimensions A and B do not include mold flash or protrusion.
- Maximum mold flash or protrusion 0.15 mm (0.006) per side
for A; for B - 0.25 mm (0.010) per side.

Symbol	Dimension, mm	
	MIN	MAX
A	12.6	13
B	7.4	7.6
C	2.35	2.65
D	0.33	0.51
F	0.4	1.27
G	1.27	
H	9.53	
J	0°	8°
K	0.1	0.3
M	0.23	0.32
P	10	10.65
R	0.25	0.75