

IN74LS05

Hex Inverters with Open-Drain Outputs

This device contains independent inverters. It performs the Boolean function $Y = \overline{A}$. The open collector outputs require pull-up resistor to perform correctly. Open-collector devices are often used to generate higher V_{OH} levels.

Pull-Up Resistor Equations

$$R_{MAX} = \frac{V_{CC}(Min) - V_{OH}}{N_1(I_{OH}) + N_2(I_{IH})}$$

$$R_{MIN} = \frac{V_{CC}(Max) - V_{OL}}{I_{OL} + N_3(I_{IL})}$$

Where: $N_1(I_{OH})$ =total maximum output high current for all outputs tied to pull-up resistor
 $N_2(I_{IH})$ =total input high current for all inputs tied to pull-up resistor
 $N_3(I_{IL})$ =total input low current for all inputs tied to pull-up resistor

LOGIC DIAGRAM

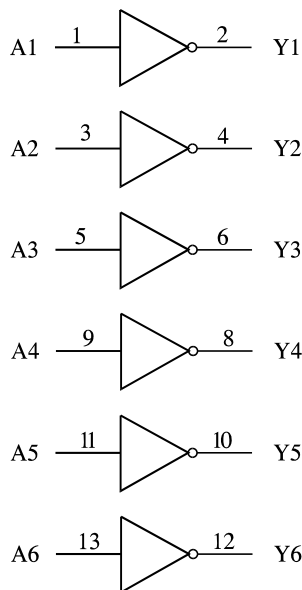

PIN 14 = V_{CC}
 PIN 7 = GND

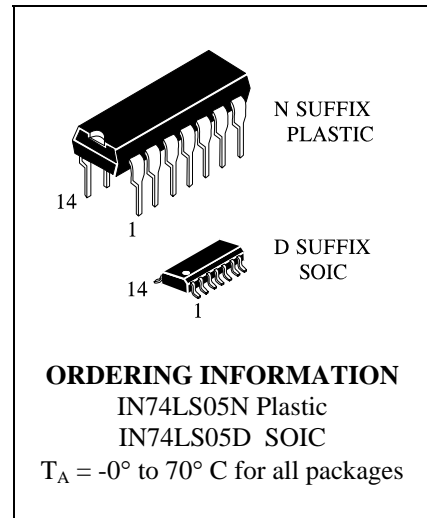

PIN ASSIGNMENT

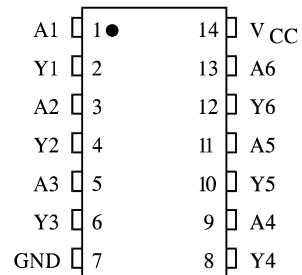

FUNCTION TABLE

Inputs	Output
A	Y
L	H
H	L

MAXIMUM RATINGS*

Symbol	Parameter	Value	Unit
V _{CC}	Supply Voltage	7.0	V
V _{IN}	Input Voltage	7.0	V
V _{OUT}	Output Voltage	7.0	V
T _{stg}	Storage Temperature Range	-65 to +150	°C

*Maximum Ratings are those values beyond which damage to the device may occur. Functional operation should be restricted to the Recommended Operating Conditions.

RECOMMENDED OPERATING CONDITIONS

Symbol	Parameter	Min	Max	Unit
V _{CC}	Supply Voltage	4.75	5.25	V
V _{IH}	High Level Input Voltage	2.0		V
V _{IL}	Low Level Input Voltage		0.8	V
V _{OH}	High Level Output Voltage		5.5	V
I _{OL}	Low Level Output Current		8.0	mA
T _A	Ambient Temperature Range	0	+70	°C

DC ELECTRICAL CHARACTERISTICS over full operating conditions

Symbol	Parameter	Test Conditions	Guaranteed Limit		Unit
			Min	Max	
V _{IK}	Input Clamp Voltage	V _{CC} = min, I _{IN} = -18 mA		-1.5	V
I _{OH}	High Level Output Current	V _{CC} = min, V _{OH} = max		0.1	mA
V _{OL}	Low Level Output Voltage	V _{CC} = min, I _{OL} = 4 mA		0.4	V
		V _{CC} = min, I _{OL} = 8 mA		0.5	
I _{IH}	High Level Input Current	V _{CC} = max, V _{IN} = 2.7 V		20	μA
		V _{CC} = max, V _{IN} = 7.0 V		0.1	mA
I _{IL}	Low Level Input Current	V _{CC} = max, V _{IN} = 0.4 V		-0.4	mA
I _{CC}	Supply Current	V _{CC} = max	Total with outputs high	2.4	mA
			Total with outputs low	6.6	

AC ELECTRICAL CHARACTERISTICS ($V_{CC} = 5.0\text{ V}$, $C_L = 15\text{ pF}$, $T_A = 25^\circ\text{C}$, $R_L = 2\text{ k}\Omega$, $t_r = 15\text{ ns}$, $t_f = 6.0\text{ ns}$)

Symbol	Parameter	Min	Max	Unit
t_{PLH}	Propagation Delay Time		32	ns
t_{PHL}	Propagation Delay Time		28	ns

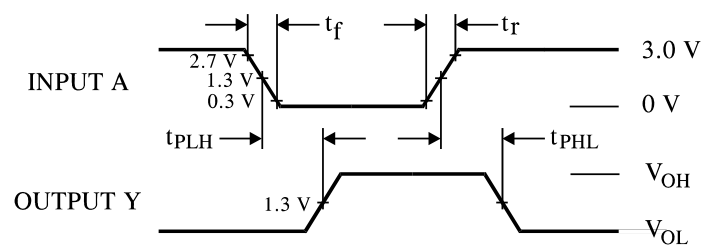
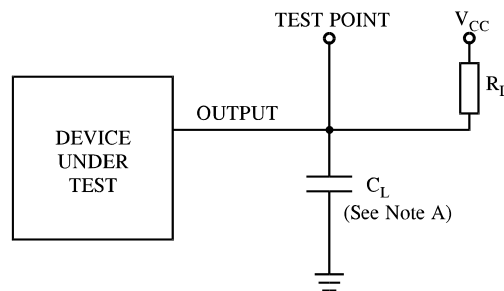

Figure 1. Switching Waveforms



NOTE A. C_L includes probe and jig capacitance.

Figure 2. Test Circuit

**N SUFFIX PLASTIC DIP
(MS - 001AA)**

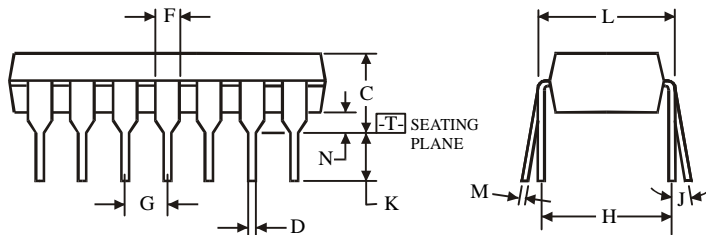
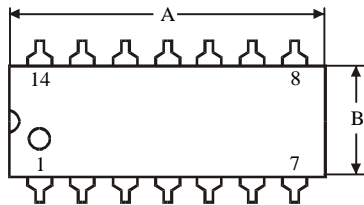
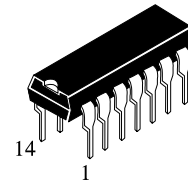

$\oplus 0.25 (0.010) \text{ (M) T}$

NOTES:

- Dimensions "A", "B" do not include mold flash or protrusions.
Maximum mold flash or protrusions 0.25 mm (0.010) per side.

Symbol	Dimension, mm	
	MIN	MAX
A	18.67	19.69
B	6.1	7.11
C		5.33
D	0.36	0.56
F	1.14	1.78
G	2.54	
H	7.62	
J	0°	10°
K	2.92	3.81
L	7.62	8.26
M	0.2	0.36
N	0.38	

**D SUFFIX SOIC
(MS - 012AB)**

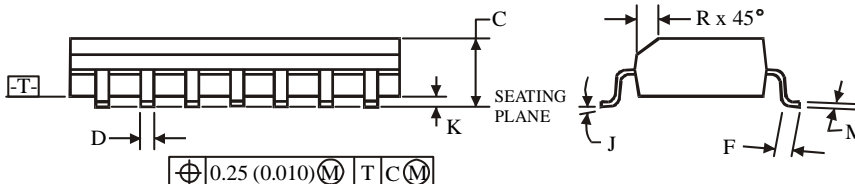
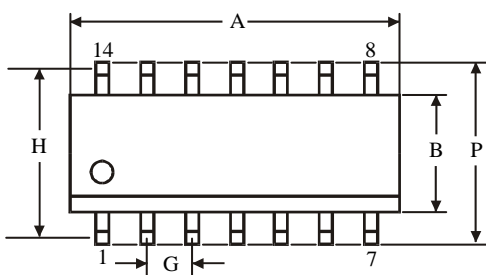
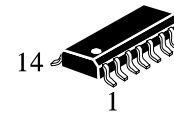

$\oplus 0.25 (0.010) \text{ (M) T C (M)}$

NOTES:

- Dimensions A and B do not include mold flash or protrusion.
- Maximum mold flash or protrusion 0.15 mm (0.006) per side for A; for B - 0.25 mm (0.010) per side.

Symbol	Dimension, mm	
	MIN	MAX
A	8.55	8.75
B	3.8	4
C	1.35	1.75
D	0.33	0.51
F	0.4	1.27
G	1.27	
H	5.27	
J	0°	8°
K	0.1	0.25
M	0.19	0.25
P	5.8	6.2
R	0.25	0.5