

Room Lamp Module

IKM3004

GENERAL DESCRIPTION

The Room Lamp module is System LED including current limiting circuit. This LED type is Blue InGaN/GaN SMD Top View 5450. The current limiting circuit limits the current at a predetermined level that is in the below the allowable range.

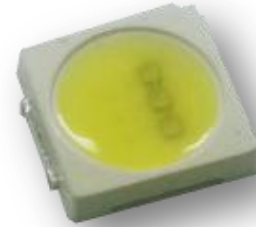

FEATURES

- ◆ System LED
- ◆ Supply voltage up to 18V
- ◆ SMD Top View 5450 type
- ◆ Beam View Angle($\Delta\theta$) : 120°
- ◆ High current accuracy at supply voltage variation
- ◆ Reduced output current at higher temperatures-negative thermal coefficient of -0.5%/K
- ◆ No EMI
- ◆ Protection of Reverse Voltage

PACKAGE INFORMATION

5.4mm x 5.0mm x 1.1T
(W x L x H)

APPLICATIONS

- ◆ Automobile Lighting

SCHEMATIC DIAGRAM

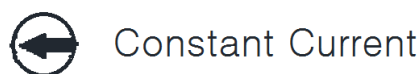
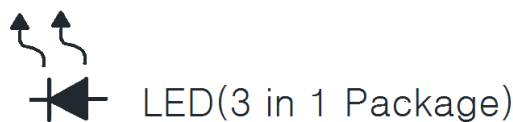
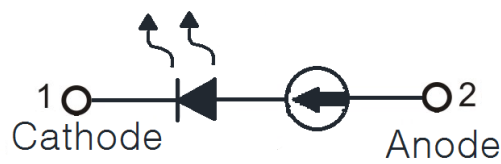

PIN LIST AND DESCRIPTIONS

Pin	Name	Description
1	Cathode	GND
2	Anode	Supply voltage

ABSOLUTE MAXIMUM RATINGS*(T_a = 25°C)

Symbol	Parameter	Conditions	Min	Max	Unit
V _F	Forward Voltage		-	30	V
V _R	Reverse voltage		-	30	V
P _D	Power Dissipation		-	1.2	W
T _{STG}	Storage temperature		-40	+100	°C

Note:

1) Exceeding these ratings may damage the device.

**Stresses beyond those listed under "Absolute Maximum Ratings" may cause permanent damage to the device. These are stress ratings only and functional operation of the device at these or any other conditions beyond those indicated in the operational sections of the specifications are not implied. Exposure to absolute maximum rating conditions for extended periods may affect device reliability.*

OPERATING RANGE

Symbol	Parameter	Min	Typ	Max	Unit
V _S	Supply voltage on pin V _S	10		18	V
T _{A 1)}	Ambient temperature range(V _F =12V)	-30		+80	°C

Note:

1) Refer to Forward Current vs Temperature of this manual.

ELECTRICAL CHARACTERISTICS The denotes the specifications which apply over the full operating temperature range, otherwise specifications are at $T_A = 25^\circ\text{C}$.

Parameter	Symbol	Condition	Min	Typ.	Max	Unit
LED Current	I_C	$V_S=12V$	57	66	75	mA
LED Current change versus T_A	$\Delta I_C/I_C$	$V_S=12V$ $V_K=3V$ $T_A=(-40 \sim 85)^\circ\text{C}$		-0.5		%/K
LED Current change versus supply voltage	$\Delta I_C/\Delta V_S$	$V_S=12V-24V$ $V_K=3.0V-15V$		1		%/V
Luminous Intensity 1)	I_V	$V_F=12V$		20,000		mcd
Viewing Angle 2)	$2\theta_{1/2}$	$V_F=12V$	100	120	140	Deg
Chromaticity Coordinates	-	$V_F=12V$		X:0.31 Y:0.32		-

Note:

- 1) Luminous intensity is measured with a light sensor and filter combination that approximates the CIE eye-response curve. Please refer to rank table.
- 2) $\theta_{1/2}$ is the off-axis angle at which the luminous intensity is half the axial luminous intensity.

CHARACTERISTICS CURVES (T_j = 25 °C)

(T_a=25 °C)

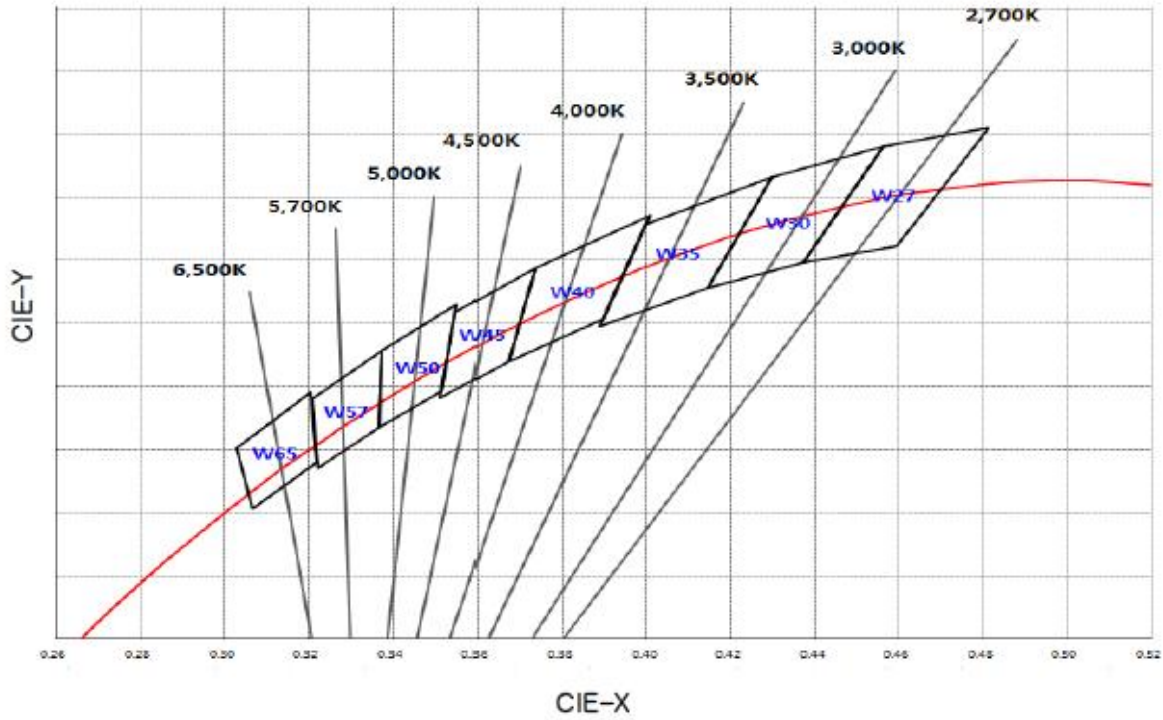

Color Coordinate

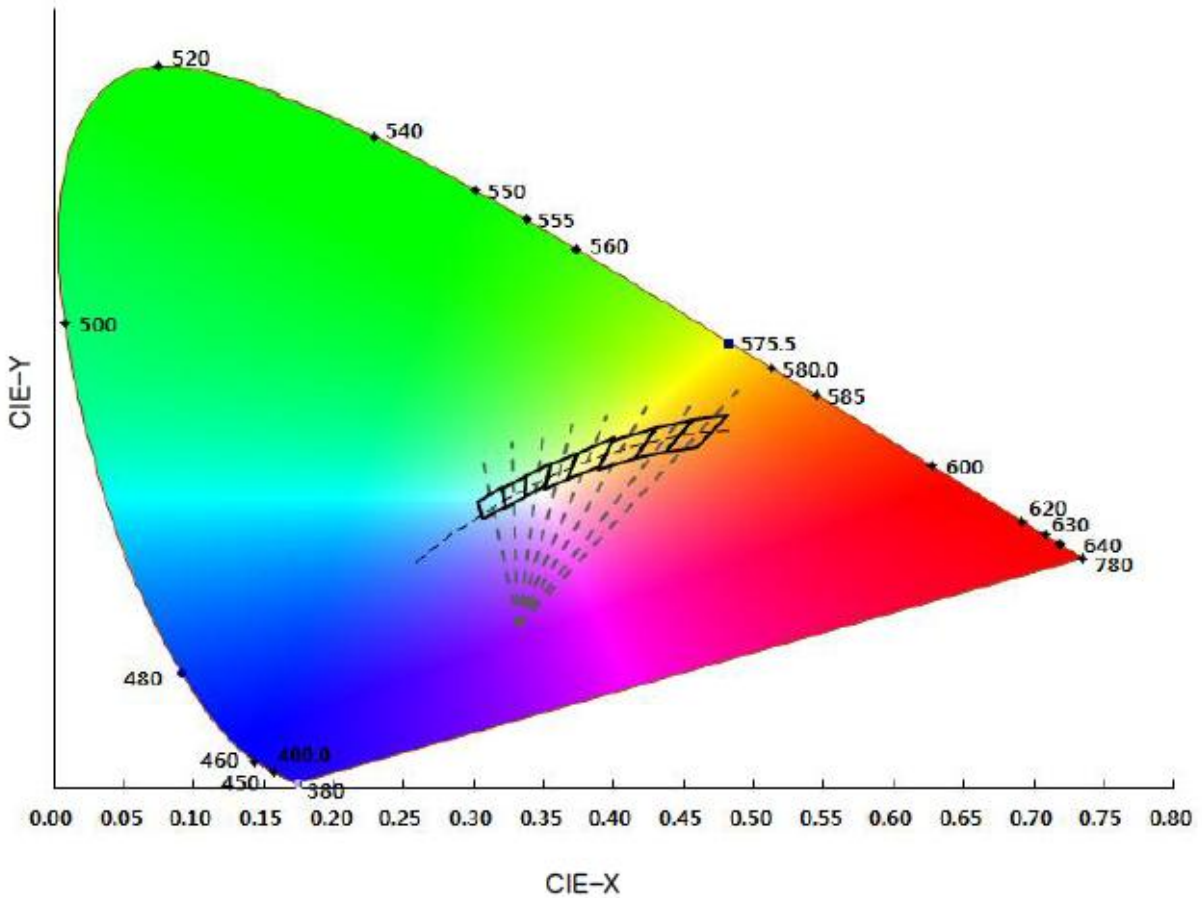

CHROMATICITY COORDINATES RANKS

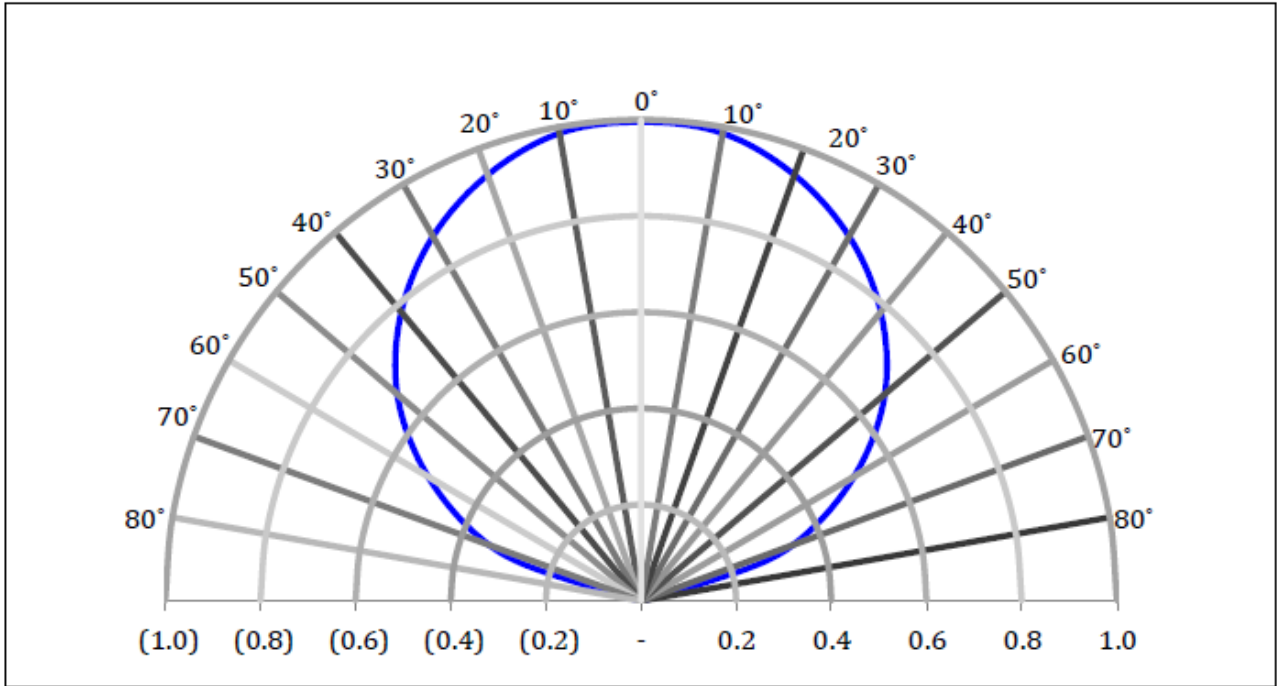

TYPICAL POLAR RADIATION PATTERN

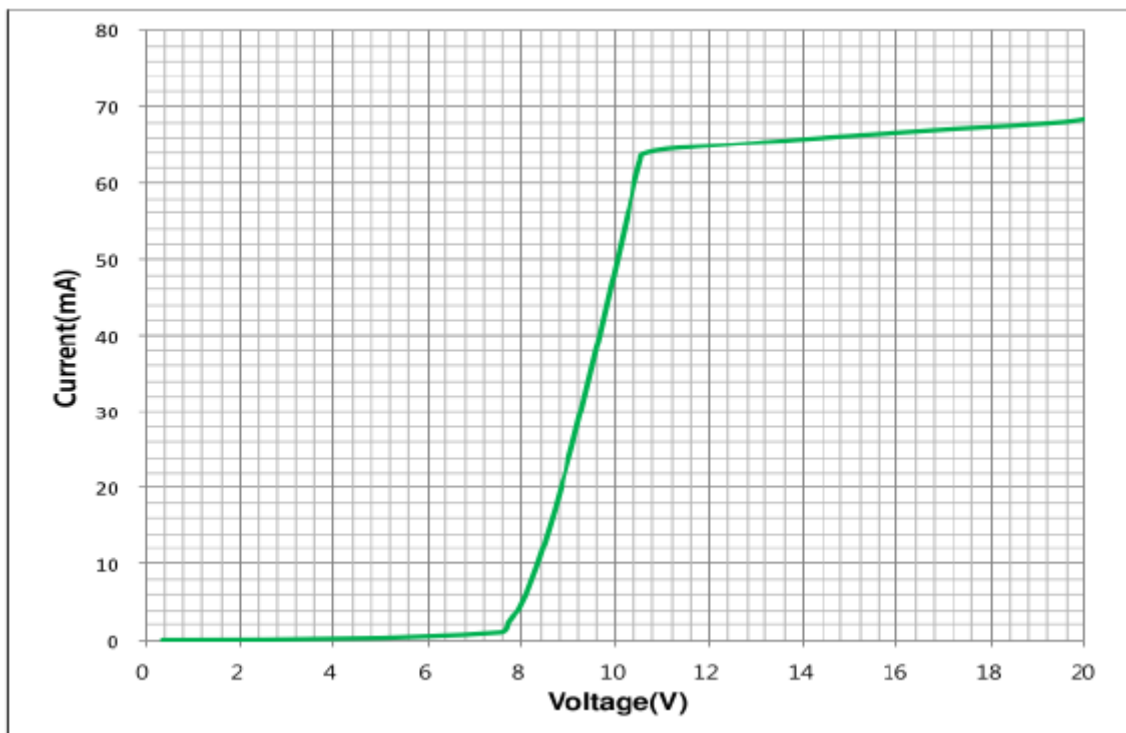

TYPICAL ELECTRICAL I-V Curve

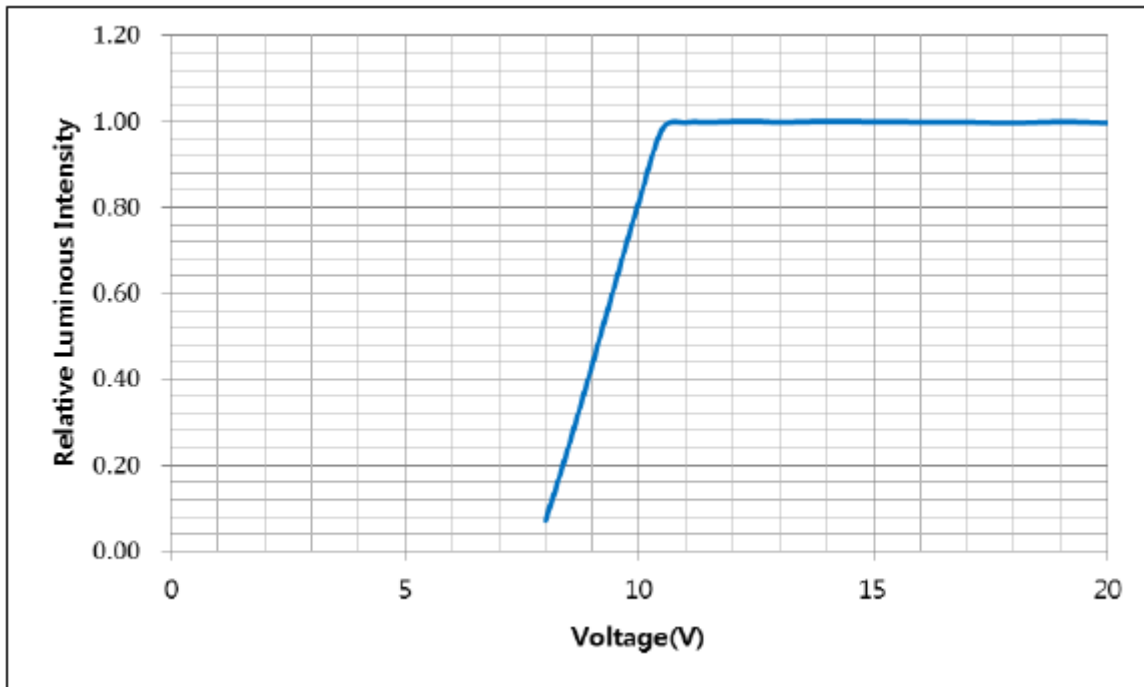

RELATIVE LUMINOUS INTENSITY vs VOLTAGE

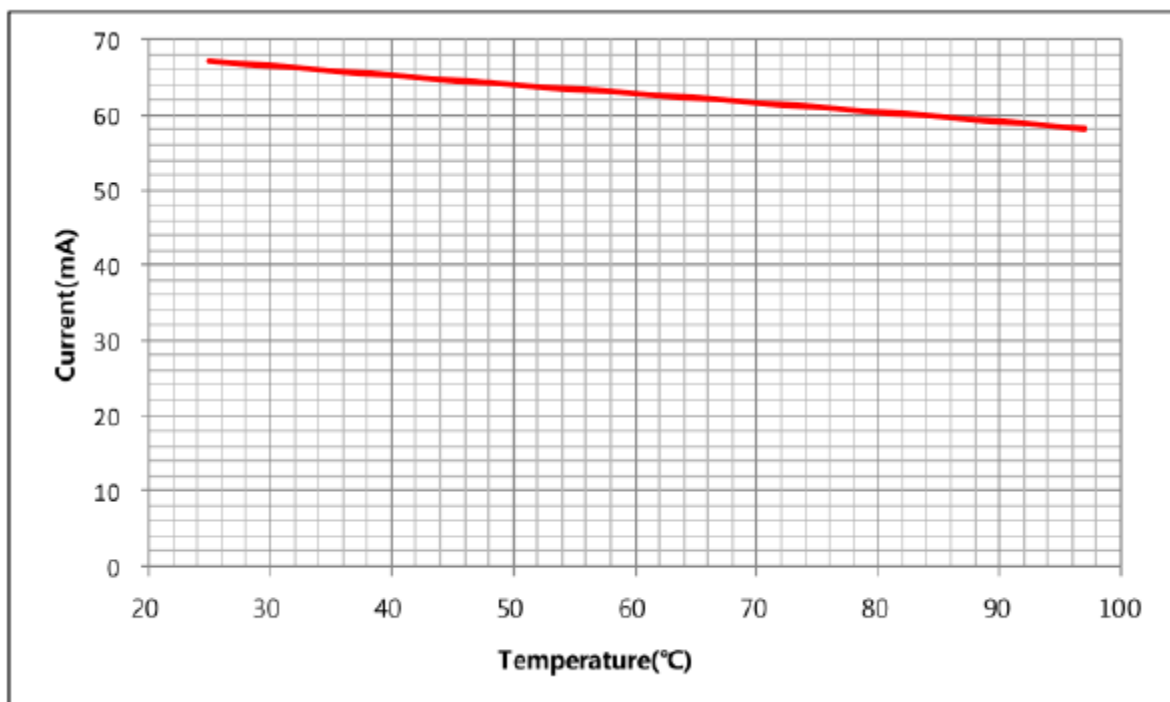

FORWARD CURRENT vs TEMPERATURE(V_F=12V)

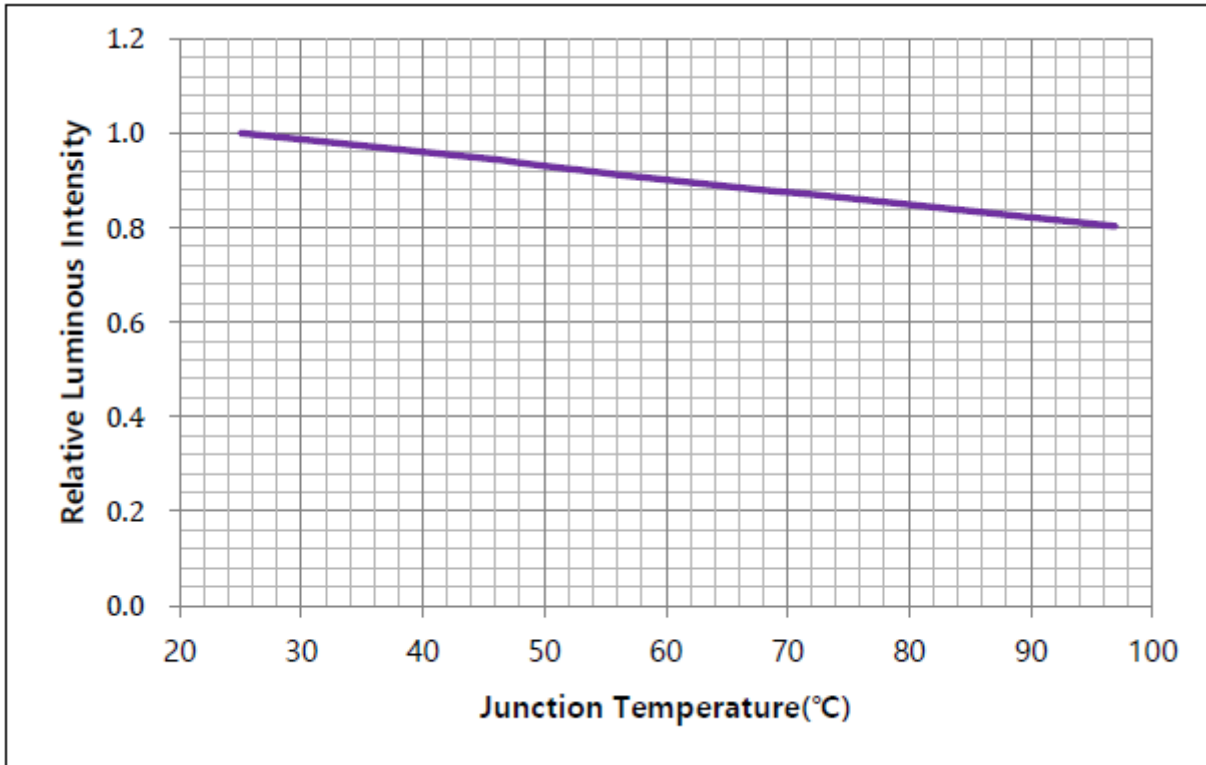

RELATIVE LUMINOUS INTENSITY vs TEMPERATURE(V_F=12V)

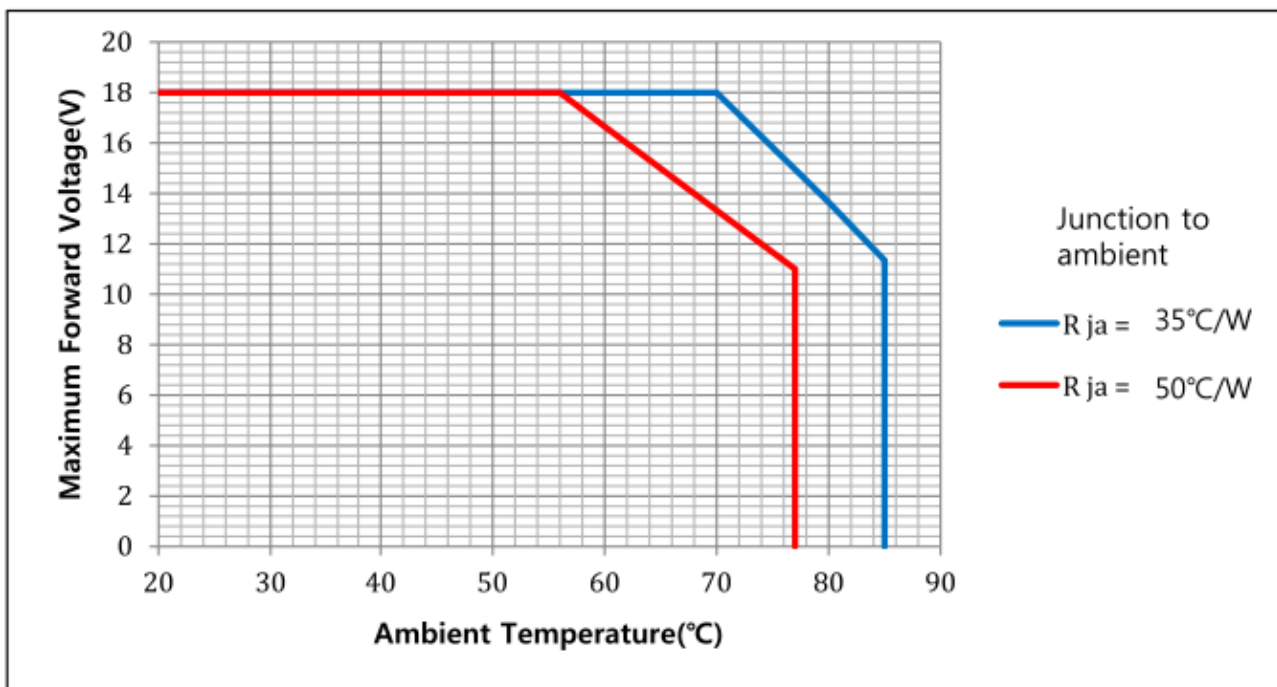

VOLTAGE DERATING CURVE

APPLICATION INFORMATION

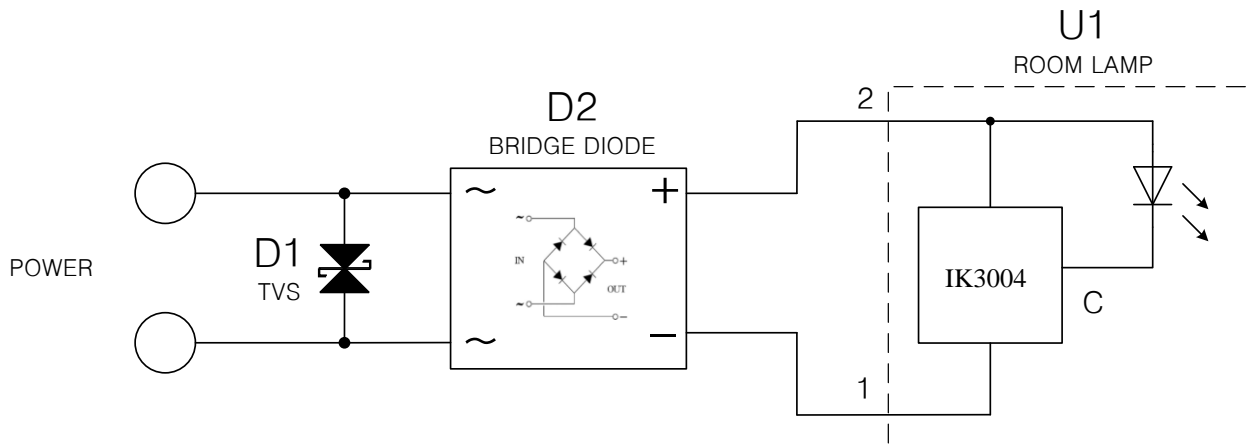

Note> Using bridge diode, it is possible to use bidirectional contact of POWER. TVS Diode is optional, not mandatory

No	ITEM	PART NAME	DESCRIPTION	MAKER	QTY
1	U1	IKM3004	3 IC + 3 LED	IK SEMICON	1
2	D1	P4SMAJ33CA-AU	TVS DIODE	PANJIT SEMICONDUCTOR	1(option)
3	D2	TS240S-AU	BRIDGE DIODE	PANJIT SEMICONDUCTOR	1

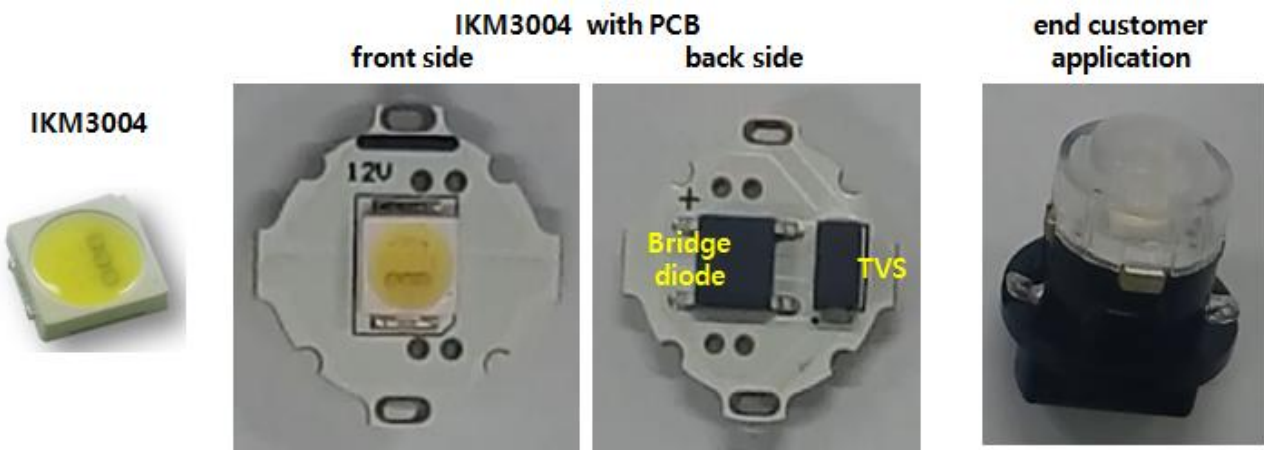

SOLDERING CONDITION

(1) Soldering condition

Reflow soldering			Hand soldering	
Step	Lead solder	Lead free Solder	Condition	Spec.
Pre heating	120~150 °C	150~200 °C	Soldering Temp.	Max 300 °C
Pre heating time	Max 120 sec.	Max 120 sec.		
Peak temp.	Max 240 °C	Max 260 °C	Soldering Time	Max 3sec.
Soldering time	Max 10 sec.	Max 10 sec.		

(2) Recommended reflow soldering profile

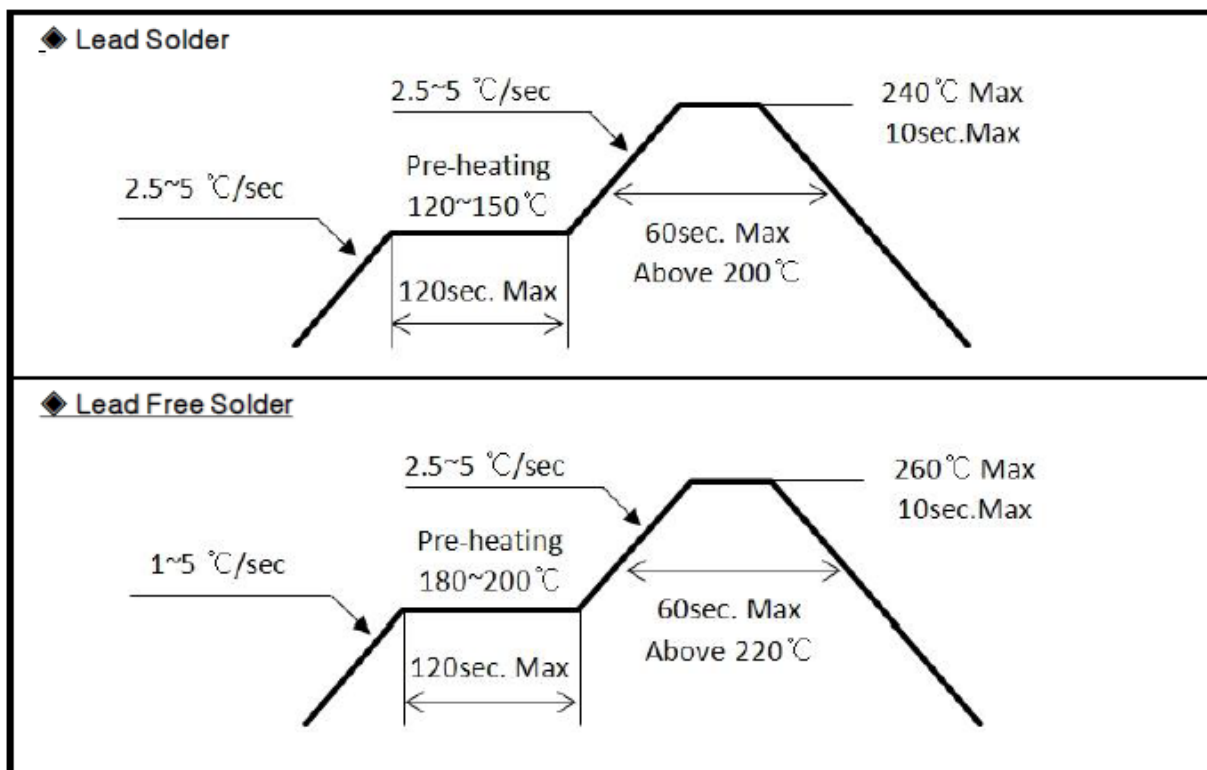

(3) Recommended soldering pattern

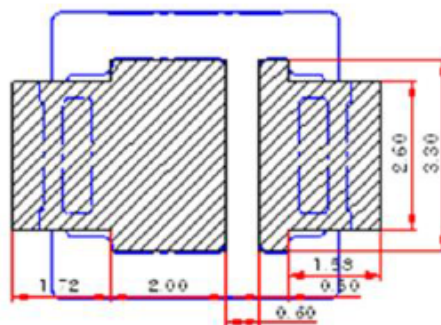

PACKAGE DIMENSION

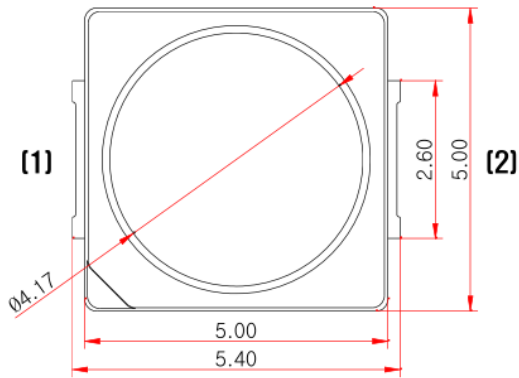

[Top view]

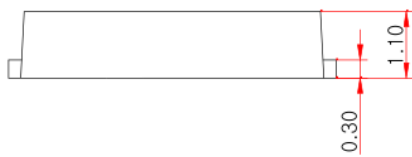

[Side view]

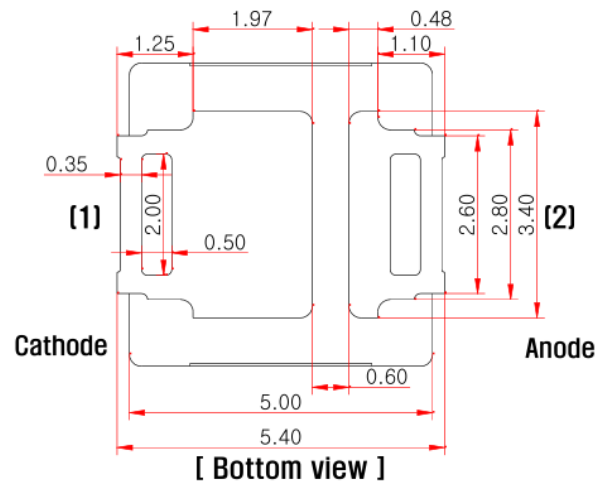

[Bottom view]