

Automotive Direction Indicator

IL33193-03

The IL33193-03 is a new generation industry standard UAA1041 “Flasher”. It has been developed for enhanced EMI sensitivity, system reliability, and improved wiring simplification. The ILC33193-03 is pin compatible with the UAA1041B..

It includes an RF filter on the fault detection pin (Pin 7) for EMI purposes.

FUTURES:

- Pin to pin Compatible with the UAA1041B
- Defective Lamp Detection Threshold
- Short Circuit Detection and Relay Shutdown
- RF Filter for EMI Purposes
- Load Dump Protection
- Double Battery Capability for Jump Start Protection
- Internal Free Wheeling Diode Protection
- AEC-Q100 Qualified

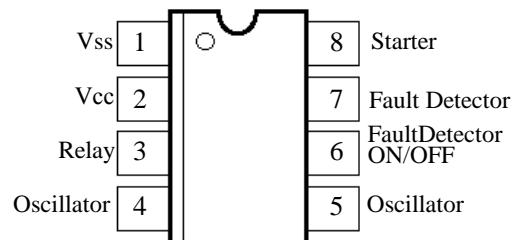
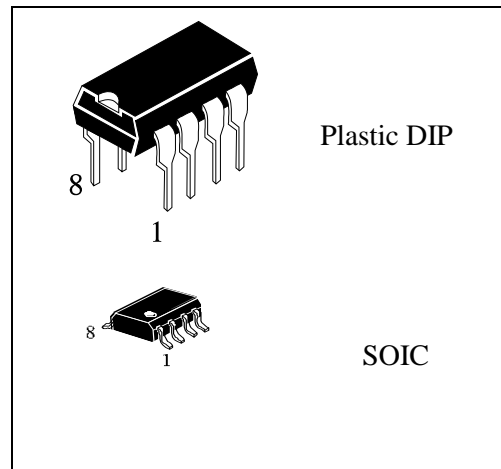

— .1 Pin Connections

ORDERING INFORMATION

Device	Operating Temperature Range	Package	Packing
IL33193-03N	$T_A = -45^\circ \text{ to } 125^\circ \text{ C}$	DIP-8	Tube
IL33193 -03D	$T_A = -45^\circ \text{ to } 105^\circ \text{ C}$	SOP-8	Tube
IL33193-03DT		SOP-8	T&R

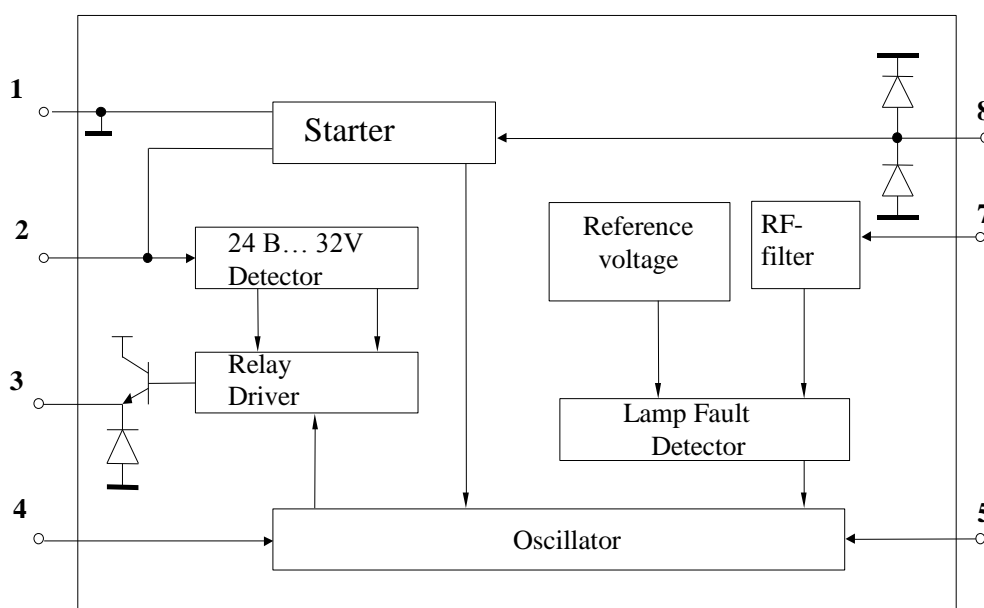

Fig. 2 Block Diagram IL33193-03

Typical Characteristics

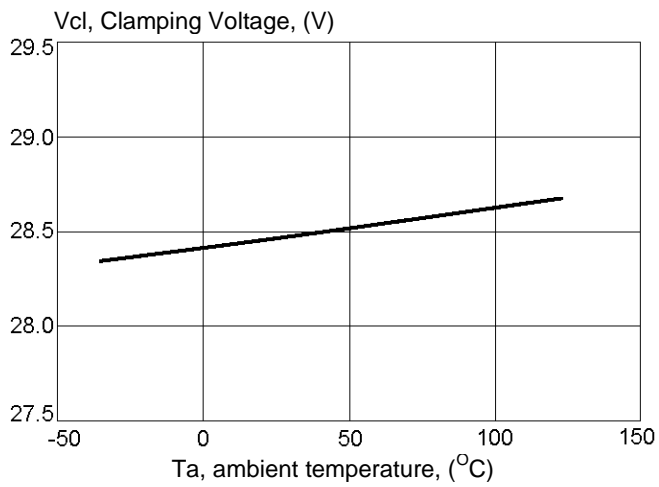

Fig 3. Clamping Voltage versus Temperature

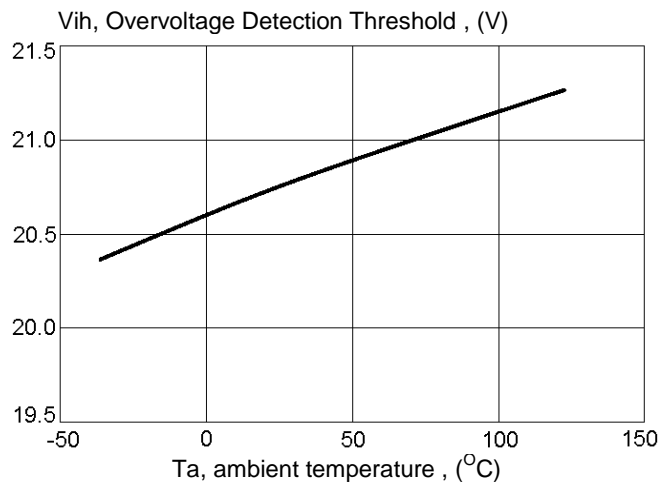

Fig. 4. Overvoltage Detection versus Temperature

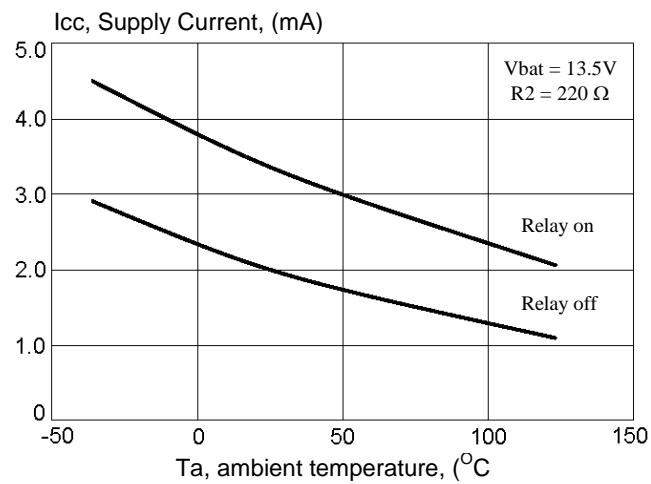

Fig. 5. Supply Current versus Temperature

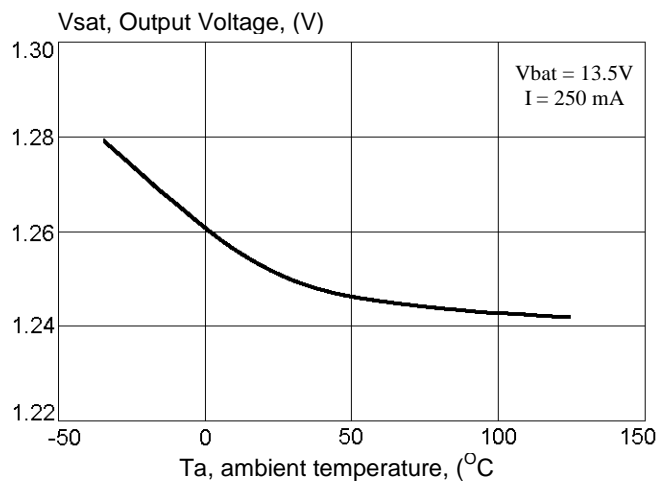

Fig. 6. Output Voltage versus Temperature

Function Description

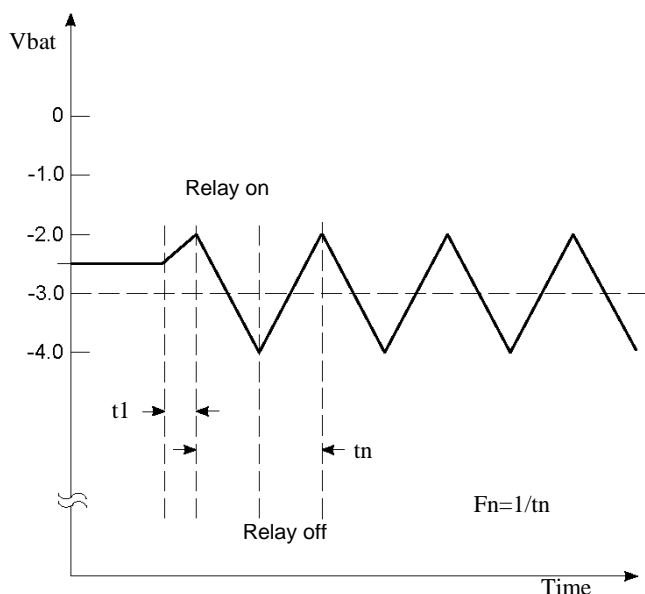

Fig. 7. Normal Operation Oscillator Timing Diagram

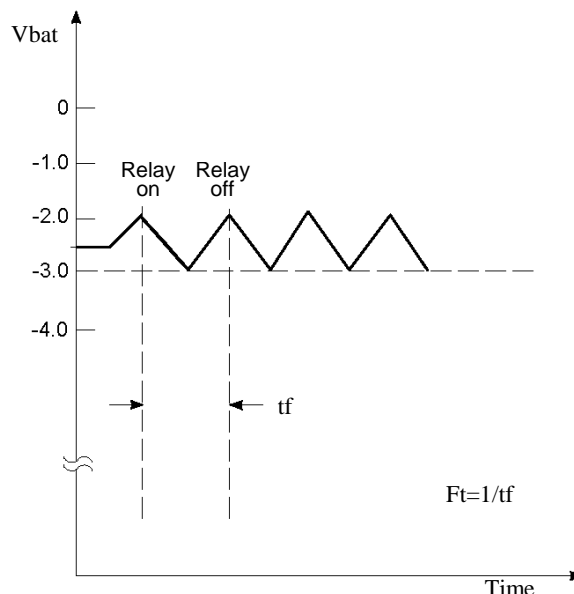

Fig. 8. One Defective Lamp Oscillator Timing Diagram

Supply and Protection Systems

Pin 1 is connected to ground via resistor R2 which limits the current in the event of any high voltage transients.

Pin 2 (VCC) is the positive supply and may be connected directly to the vehicle's battery voltage.

Overvoltage and Double Battery Protection: When the applied VCC to VSS voltage is greater than 22 V, the overvoltage detector circuit turns the relay driver off. Both the device and the lamps are protected if two 12 V batteries are connected in series and used to jump start the vehicle.

Load Dump Overvoltage Protection: A 29 V overvoltage detector protects the circuits against high voltage transients due to load dumps and other low energy spikes. The relay driver is automatically turned on whenever the VCC to VSS voltage is greater than 32 V.

Overvoltage Protection, High Voltage Transients: The Enable and the Starter pins are protected against positive and negative transients by internal on-chip diodes.

On-Chip Relay Driver

The device directly drives the flasher relay. The output structure is an Emitter of an NPN transistor. It contains the free wheeling diode circuitry necessary to protect the device whenever the relay is switched off.

Oscillator

The device uses a sawtooth oscillator (Figure 7). The frequency is determined by the external components C1 and R1. In the normal operating mode, the flashing frequency is: $F_n = 1/R_1 \cdot C_1 \cdot K_n$. With a defective (open) 21 W lamp (Figure 8), the flashing frequency changes to: $F_n = 2.5 \cdot F_n$.

The typical first flash delay (the time between the moment when the indicator switch is closed and the first lamp flash occurs) is: $t_1 = K_1 \cdot R_1 \cdot C_1$ Where a 21 W lamp opens, the delay is expressed as: $t_2 = K_2 \cdot R_1 \cdot C_1$

Short circuit detection delay $t_3 = K_1 \cdot R_1 \cdot C_1$.

Starter

Pin 8 is connected through a 2.2 k Ω resistor to the flashing lamp. Pin 8 is the input to the Starter function and senses the use of S1 by sensing ground through the lamp (Figure 9).

Lamp Fault Detector with Internal RF Filter

A Lamp defect is sensed by the lamp fault detector's monitoring of the voltage developed across the external shunt resistor R4 via the RF filter. The RS voltage drop is compared to a Vbat dependent internal reference voltage (Vref) to validate the comparison over the full battery voltage range. A detected fault causes the oscillator to change frequency (Figure 8).

Short Circuit Detector

Detects excessive current ($I_{sh} > 25\text{ A}$) flowing in the shunt resistor R4. The detection takes place after a time delay of t_3 ($t_3 = 55\text{ ms}$). In this case, the relay will be turned off. The circuit is reset by switching S1 to the off position.

Operation with Short Circuit Detection

Pin 6 has to be left open and a capacitor C2 has to be connected between Pin 1 and Pin 2.

Operation without Short Circuit Detection

Pin 6 has to be connected to Pin 2, and the use of capacitor C2 is not necessary.

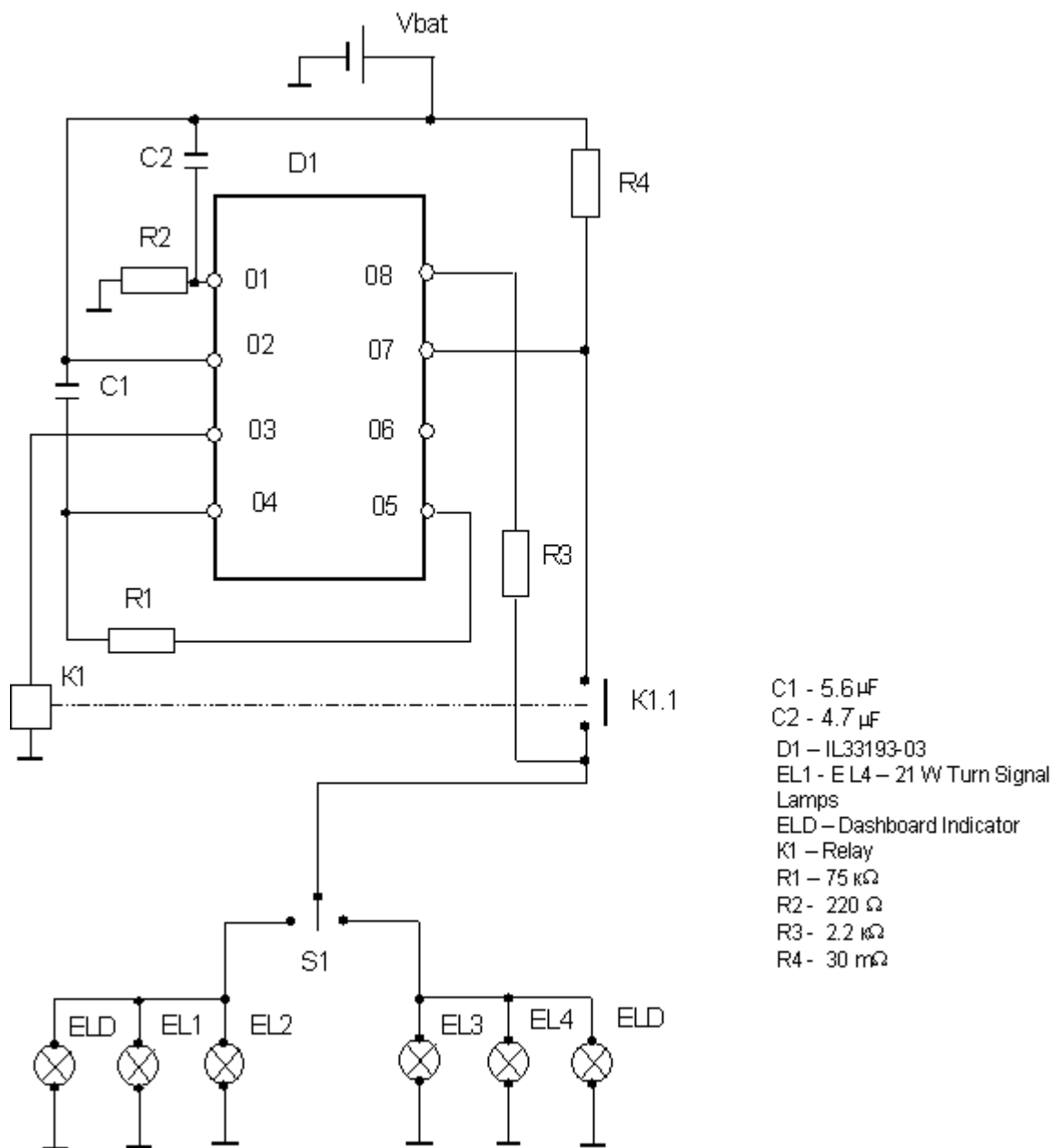

Fig. 9. IL33193-03 Typical Application

Table 1- Electrical Characteristics (8.0V ≤ Vcc=Vbat ≤ 18V)

Characteristic	Unit	Symbol	Limits		Temperature T _A , °C
			Min	Max	
Battery Voltage Range (Normal Operation)	V	Vb	8.0	18	-45÷+125
Overvoltage Detector Threshold (VPin2 – VPin1)	V	Vih	19	22	-45÷+125
Clamping Voltage (R2 = 220 Ω)	V	Vcl	27	32	-45÷+125
Short Circuit Detector Threshold (Vpin2-Vpin7)	V	Dth(sc)	0,63	0,77	25±10
Output Voltage [I = -250 mA (VPin2 – VPin3)]	V	Vsat	-	1,5	-45÷+125
Oscillator Constant (Normal Operation)		Kn	1.3	1.75	25±10
			1.25	1.85	-45÷+125
Duty Cycle (Normal Operation)	%	-	45	55	-45÷+125
Oscillator Constant (One 21 W Lamp Defect)		Kf	0.45	0.75	25±10
			0.41	0.85	-45÷+125
Oscillator Constant		K1 K2 K3	0.150	0.240	25±10
			0.200	0.290	
			0.126	0.14	
Duty Cycle (One 21 W Lamp Defect)		-	35	45	-45÷+125
Current Consumption (Relay “Off ”), Vbat = 13.5 V, R2 = 220 Ω	mA	lcc	-	5.3	-45÷+125
Current Consumption (Relay “On ”), Vbat = 13.5 V, R2 = 220 Ω	mA	lcc		7.8	-45÷+125
Defect Lamp Detector Threshold [R2 = 220Ω, (VPin2 – VPin7) , Vbat = 13.5 V]	mV	Vs	75	95	-45÷+125

Table 2 - MAXIMUM RATINGS

Rating, Symbol,	Min	Max	Unit
Operation Ambient Temperature Range	-45	125	°C
Storage Temperature Range	-65	150	°C
Pin 1 Positive Current (Continuous/Pulse), I1+		150/500	mA
Pin 1 Negative Current (Continuous/Pulse), I1-		-35/-500	mA
Pin 2 Current (Continuous/Pulse), I2		±350/±1900	mA
Pin 3 Current (Continuous/Pulse), I3		±300/±1400	mA
Pin 2 Current (Continuous/Pulse), I8		±25/±50	mA
ESD (All Pins Except Pin 4 for Negative Pulse), Vesd		±2000	V
ESD (Pin 4 Negative Pulse), Vesd4-		-1000	V

* Stresses beyond those listed under “absolute maximum ratings” may cause permanent damage to the device. These are stress ratings only and functional operation of the device at these or any other conditions beyond those indicated under “recommended operating conditions” is not implied. Exposure to absolute-maximum-rated conditions for extended periods may affect device reliability.

**N SUFFIX PLASTIC DIP
(MS – 001BA)**

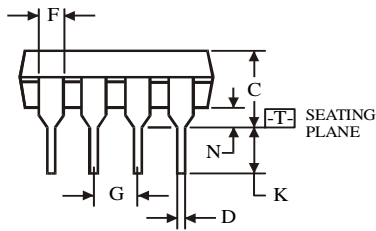
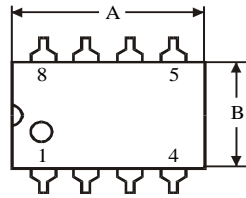
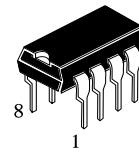

$\oplus 0.25 (0.010) \text{ (M) T}$

Dimension, mm		
Symbol	MIN	MAX
A	8.51	10.16
B	6.1	7.11
C		5.33
D	0.36	0.56
F	1.14	1.78
G	2.54	
H	7.62	
J	0°	10°
K	2.92	3.81
L	7.62	8.26
M	0.2	0.36
N	0.38	

NOTES:

- Dimensions “A”, “B” do not include mold flash or protrusions.
Maximum mold flash or protrusions 0.25 mm (0.010) per side.

**D SUFFIX SOIC
(MS - 012AA)**

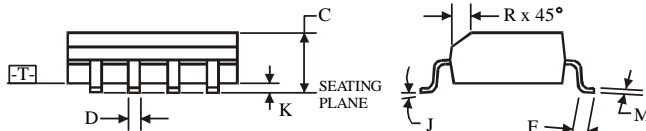
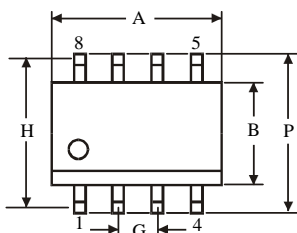
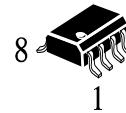

$\oplus 0.25 (0.010) \text{ (M) T C (M)}$

Dimension, mm		
Symbol	MIN	MAX
A	4.8	5
B	3.8	4
C	1.35	1.75
D	0.33	0.51
F	0.4	1.27
G	1.27	
H	5.72	
J	0°	8°
K	0.1	0.25
M	0.19	0.25
P	5.8	6.2
R	0.25	0.5

NOTES:

- Dimensions A and B do not include mold flash or protrusion.
- Maximum mold flash or protrusion 0.15 mm (0.006) per side
for A; for B - 0.25 mm (0.010) per side.