

Dual Operational Amplifiers

IL4558

The IL4558 is dual general purpose operational amplifiers. The high common-mode input voltage range and the absence of latch-up make these amplifiers ideal for voltage follower application. The devices are short circuit protected and the internal frequency Compensation ensures stability without external components.

FEATURE

- Short Circuit Protection
- Wide common-mode and differential ranges
- No frequency compensation required
- Low power consumption
- No latch-up
- 3 MHz unity gain bandwidth guaranteed
- Gain and phase match between amplifiers
- Possible to exchange the position of Pin9 for Pin1 because of Pin Connection being symmetric(IL4558S only)

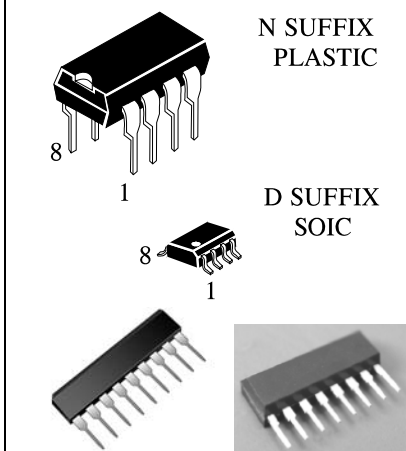

ORDERING INFORMATION

IL4558N Plastic
 IL4558D SOIC
 IL4558S-9 SIP-9
 IL4558S SIP-8

$T_A = -40^\circ$ to 85° C for all packages.

BLOCK DIAGRAM

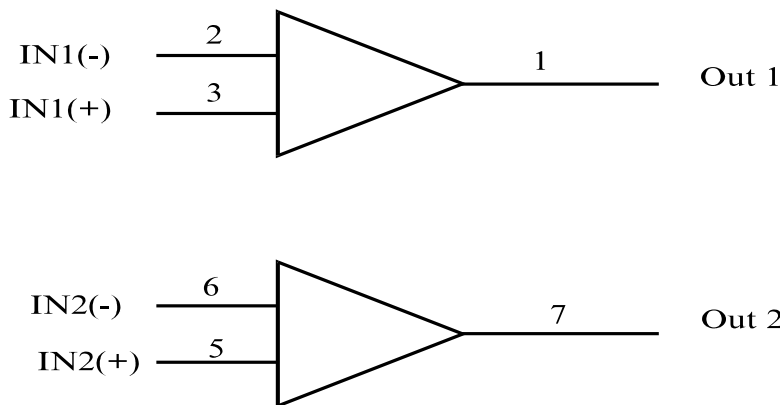

PIN 4 = GND (V⁻)

PIN 8 = V_{CC} (V⁺)

PIN ASSIGNMENT

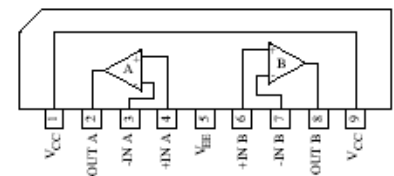
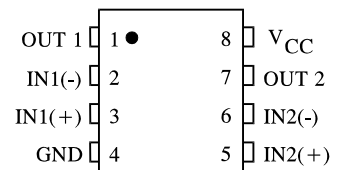

SCHEMATIC DIAGRAM

(One Section Only)

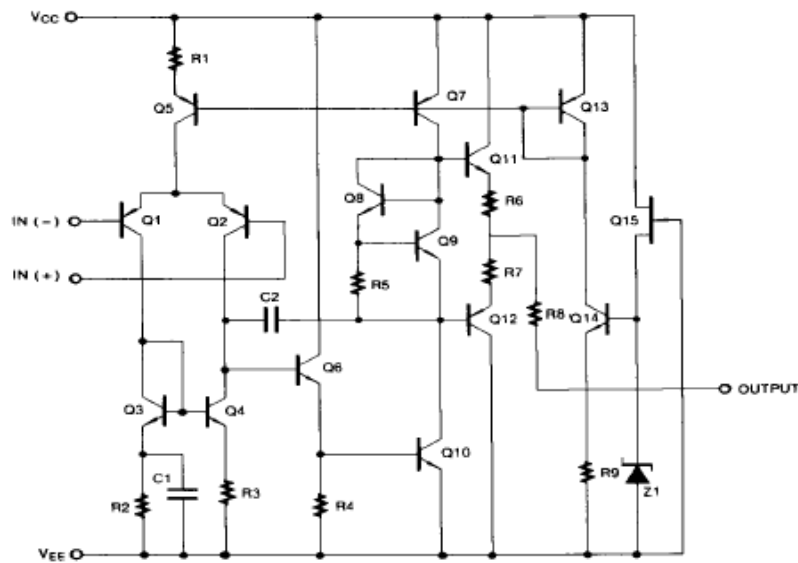

MAXIMUM RATINGS*

Symbol	Parameter	Value	Unit
V ⁺	Supply Voltage	18	V
V ⁻	Supply Voltage	-18	V
V _{IDR}	Differential Input Voltage	±30	V
V _{IN}	Input Voltage	±15	V
P _D	Power Dissipation in Still Air	570	mW
T _a	Operation Temperature Range	-40 to 85	°C
T _{stg}	Storage Temperature Range	-55 to 125	°C

* Stresses beyond those listed under “absolute maximum ratings” may cause permanent damage to the device. These are stress ratings only and functional operation of the device at these or any other conditions beyond those indicated under “recommended operating conditions” is not implied. Exposure to absolute-maximum-rated conditions for extended periods may affect device reliability.

Functional operation should be restricted to the Recommended Operating Conditions.

RECOMMENDED OPERATING CONDITIONS

Symbol	Parameter	Min	Max	Unit
V ⁺	Supply Voltage		16	V
V ⁻	Supply Voltage		-16	V

ELECTRICAL CHARACTERISTICS ($T_A = 25^\circ\text{C}$, $V^+ = +15\text{ V}$, $V^- = -15\text{ V}$)

Symbol	Parameter	Test Conditions	Guaranteed Limits		Unit
			Min	Max	
V_{IO}	Input Offset Voltage	$R_S \leq 10\text{K}\Omega$		± 5.0	mV
I_{IO}	Input Offset Current			± 200	nA
I_{IB}	Input Bias Current			- 500	nA
r_i	Input Resistance		0.3		$\text{M}\Omega$
A_V	Large-Signal Voltage Gain	$R_L \geq 2\text{K}\Omega$, $V_C = \pm 10\text{V}$	20		V/mV
V_{OM}	Output Voltage Swing	$R_L \geq 10\text{K}\Omega$	± 12		V
		$R_L \geq 2\text{K}\Omega$	± 10		V
V_{ICR}	Input Common-Mode Voltage Range		± 12		V
CMRR	Common Mode Rejection Ratio	$R_S \leq 10\text{K}\Omega$	70		dB
PSRR	Supply Voltage Rejection Ratio	$R_S \leq 10\text{K}\Omega$		150	$\mu\text{V}/\text{V}$
SR	Slew Rate	$R_L \geq 2\text{K}\Omega$	0.8	1.6	
I^+, I^-	Supply Current			5.6	mA
SR	Slew Rate	$R_L = 2\text{K}\Omega$			$\text{V}/\mu\text{s}$
P_C	Power Consumption	$R_L = \infty$		170	mW
V_N	Input Noise Voltage	$R_S = 1\text{K}\Omega$ $f = 30\text{Hz} \sim 30\text{KHz}$		3.5	μV_{rms}
I_{source}	Source Current		- 20		mA
I_{sink}	Sink Current		20		mA

Transient Response Test Circuit

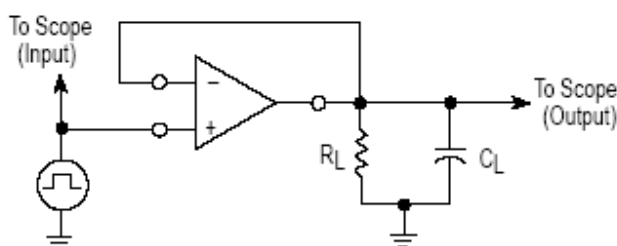

Unused OpAmp

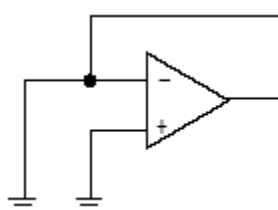

TYPICAL PERFORMANCE CURVES

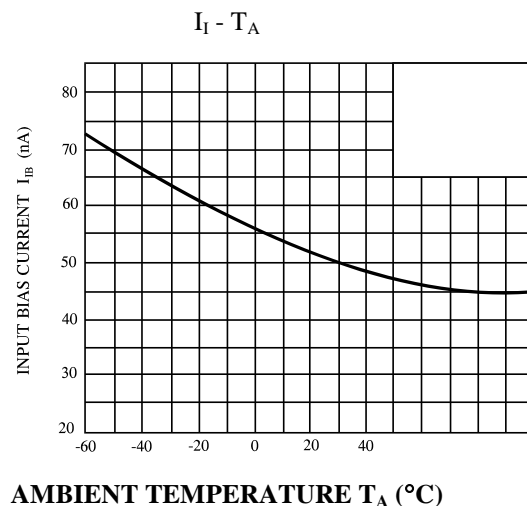
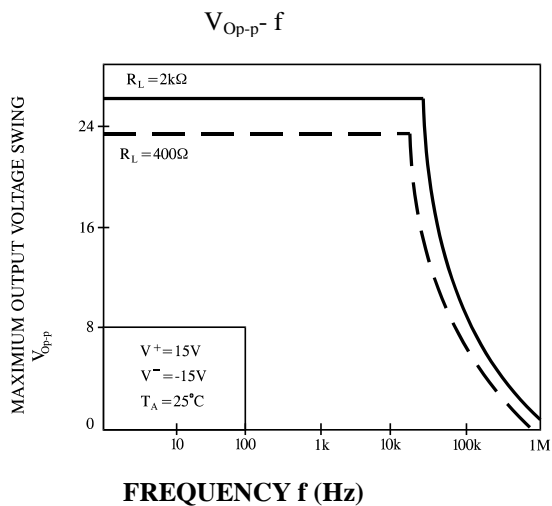
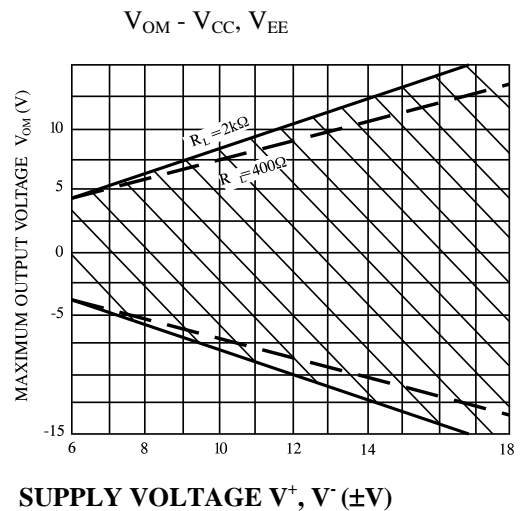
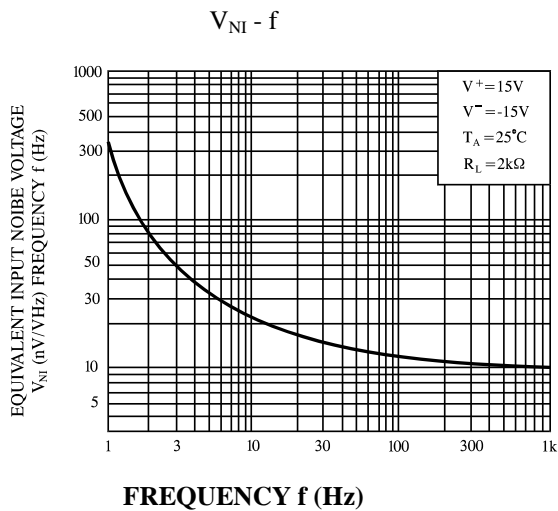
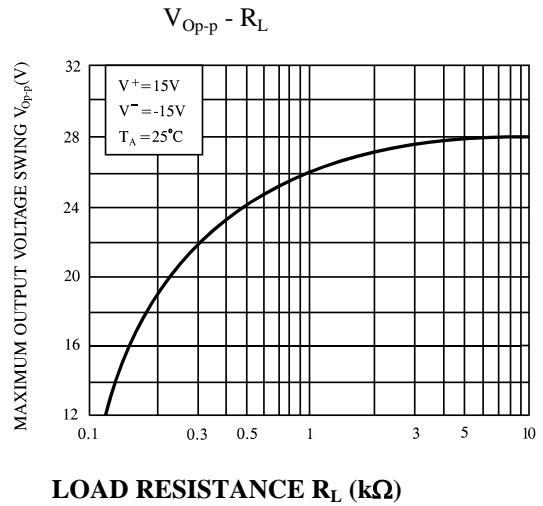
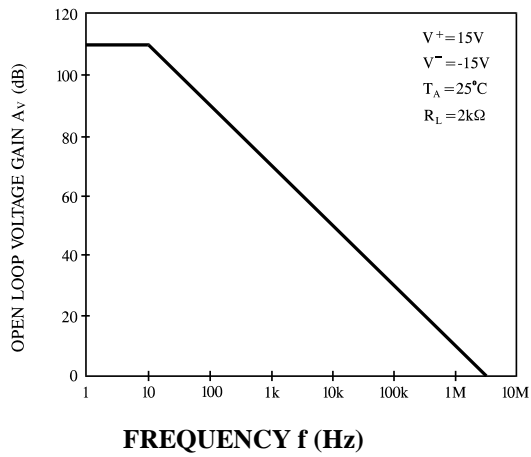

**N SUFFIX PLASTIC DIP
(MS - 001BA)**

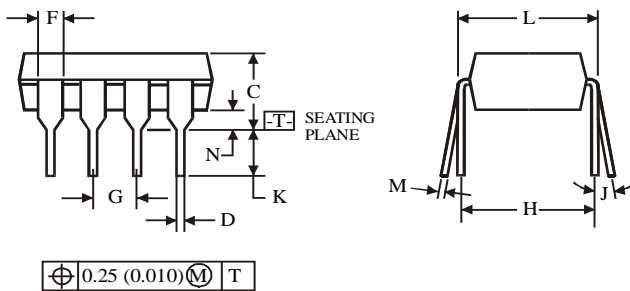
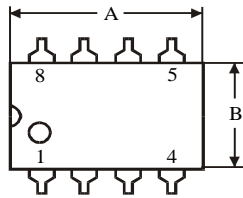
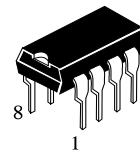

Symbol	Dimension, mm	
	MIN	MAX
A	8.51	10.16
B	6.1	7.11
C		5.33
D	0.36	0.56
F	1.14	1.78
G	2.54	
H	7.62	
J	0°	10°
K	2.92	3.81
L	7.62	8.26
M	0.2	0.36
N	0.38	

NOTES:

- Dimensions "A", "B" do not include mold flash or protrusions.
Maximum mold flash or protrusions 0.25 mm (0.010) per side.

**D SUFFIX SOIC
(MS - 012AA)**

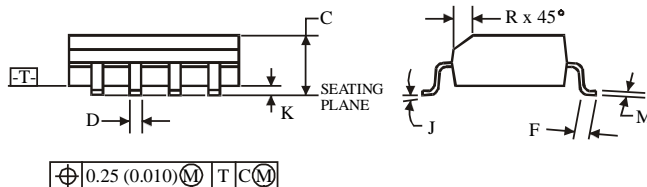
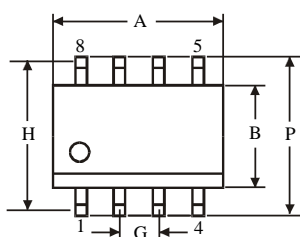
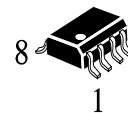

Symbol	Dimension, mm	
	MIN	MAX
A	4.8	5
B	3.8	4
C	1.35	1.75
D	0.33	0.51
F	0.4	1.27
G	1.27	
H	5.72	
J	0°	8°
K	0.1	0.25
M	0.19	0.25
P	5.8	6.2
R	0.25	0.5

NOTES:

- Dimensions A and B do not include mold flash or protrusion.
- Maximum mold flash or protrusion 0.15 mm (0.006) per side
for A; for B - 0.25 mm (0.010) per side.

SIP-9

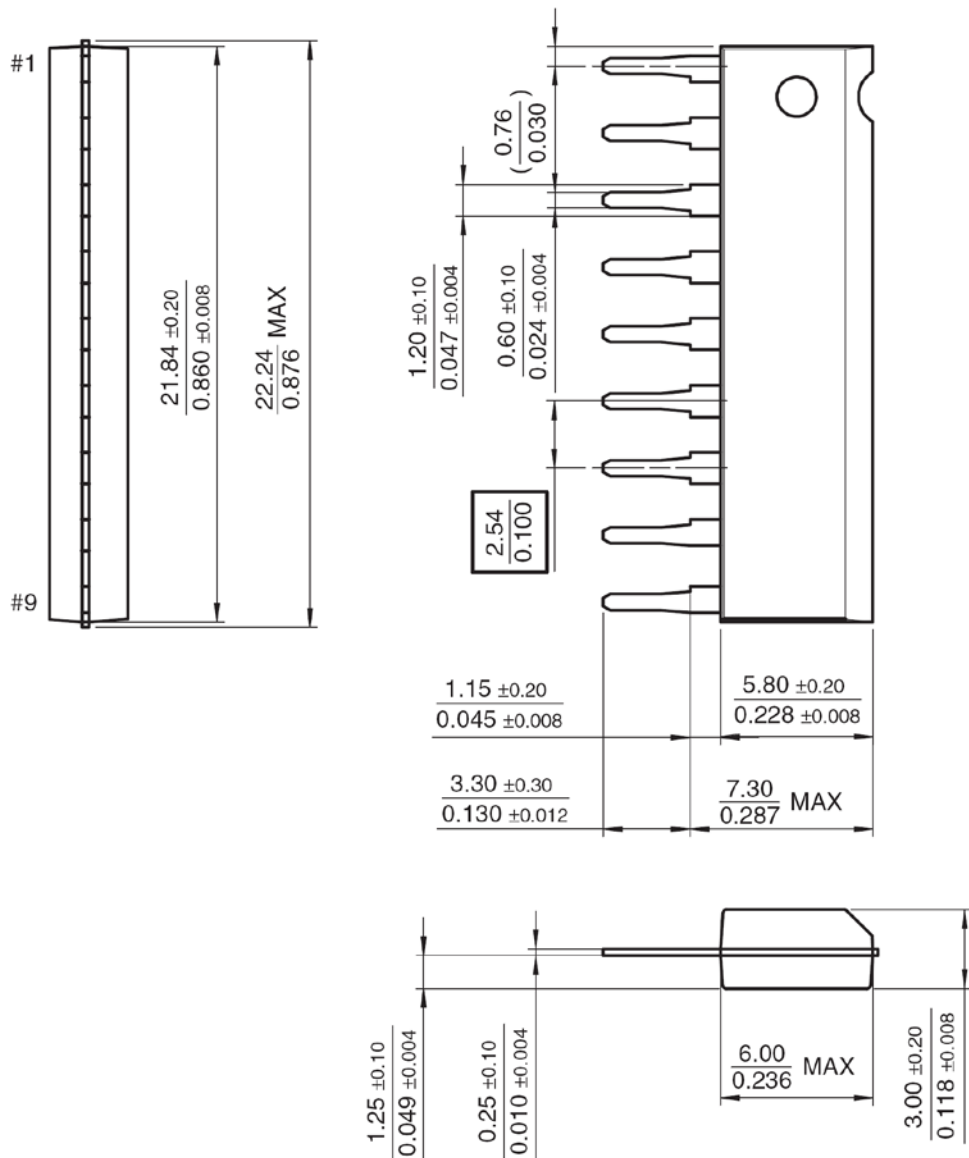
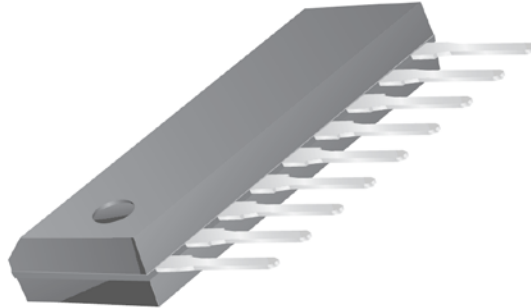

SIP-8

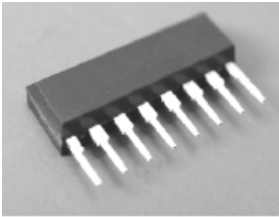

Lead Pitch	2.54mm(100mil)
Pad Size	102mil×102mil
Unit	mm(inch)

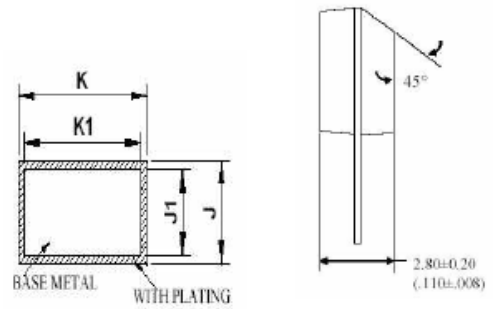
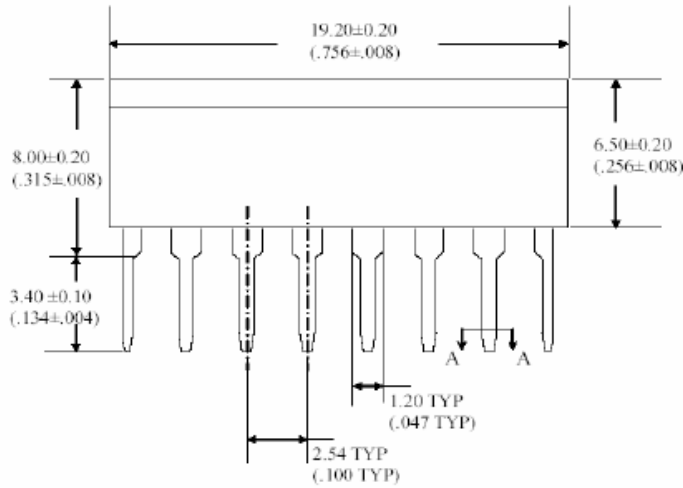

SECTION A-A

DIM	MILLIMETERS		INCHES	
	MIN	MAX	MIN	MAX
J	0.219	0.339	.0086	.0133
J1	0.219	0.289	.0086	.0114
K	0.500	0.650	.0197	.0258
K1	0.500	0.550	.0197	.0217