

CMOS General Purpose Timer

ILC555

The ILC555 is CMOS RC timers providing significantly improved performance over the standard SE/NE555 and 355 timers, while at the same time being direct replacements for those devices in most applications. Improved parameters include low supply current, wide operating supply voltage range, low THRESHOLD, TRIGGER and RESET currents, no crowbaring of the supply current during output transitions, higher frequency performance and no requirement to decouple CONTROL VOLTAGE for stable operation.

Specifically, the ILC555 is stable controller capable of producing accurate time delays of frequencies.

- Exact equivalent in most cases for SE/NE555.
- Low Supply Current.
- High speed operation – 500 kHz guaranteed.
- Wide operation supply voltage range – 2 to 18 volts.
- Timing from microseconds through hours.
- Operates in both astable and monostable modes.
- Adjustable duty cycle.
- High output source/sink driver can drive TTL/CMOS

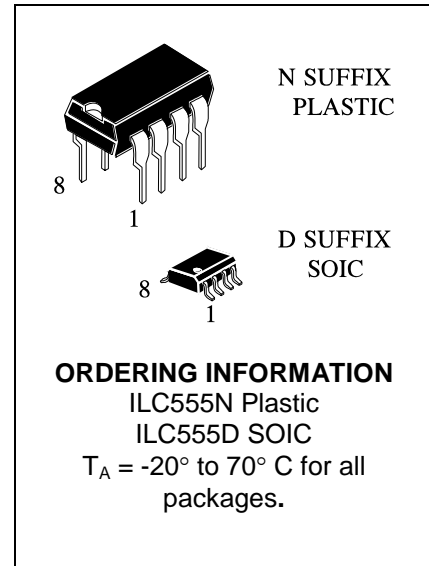

PIN ASSIGNMENT

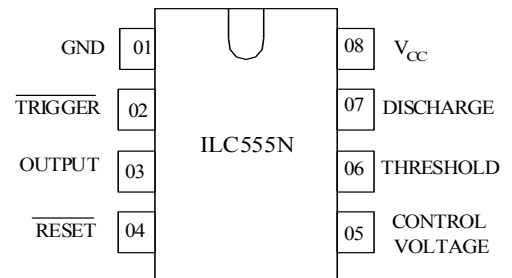

TRUTH TABLE

THRESHOLD	TRIGGER	RESET	OUTPUT	DISCHARGE
X	X	L	L	ON
$> 2/3 \cdot V_{CC}$	$> 1/3 \cdot V_{CC}$	H	L	ON
$< 2/3 \cdot V_{CC}$	$> 1/3 \cdot V_{CC}$	H	STABLE	STABLE
X	$< 1/3 \cdot V_{CC}$	H	H	OFF

MAXIMUM RATINGS AND RECOMMENDED OPERATING CONDITIONS

Parameter, unit	Symbol	Recommended operating conditions		Maximum ratings	
		Value		Value	
		min	max	min	max
Supply Voltage, V	V_{CC}	2.0	18.0	0	18.0
Output Current, mA	I_O	-	20	-	100
Input Voltage, V	$V_{TH}, V_{TRIG}, V_{RST}$	-	-	-0.3	$V_{CC}+0.3$
Power Dissipation, mW	P_D	-	-	-	200
Operating Temperature, °C	T_{OPR}	-20	70	-20	85
Storage Temperature, °C	T_{STG}	-	-	-65	150
Lead Temperature, 1 mm from Case for 10 Seconds, °C	T_{SOLDER}	-	-		260

* Stresses beyond those listed under “absolute maximum ratings” may cause permanent damage to the device. These are stress ratings only and functional operation of the device at these or any other conditions beyond those indicated under “recommended operating conditions” is not implied. Exposure to absolute-maximum-rated conditions for extended periods may affect device reliability.

DC ELECTRICAL CHARACTERISTICS (Voltages Referenced to GND)

Parameter, units	Symbol	Test Conditions		Value		Temperature, °C
		I _{OL} , I _{OH}	V _{CC} , B	min	max	
Threshold Voltage, V	V _{TH}		5.0	0.65 V _{CC}	0.70 V _{CC}	25±10
				0.60 V _{CC}	0.80 V _{CC}	-20, 70
Trigger voltage, V	V _{TRIG}		5.0	0.31 V _{CC}	0.36 V _{CC}	25±10
				0.28 V _{CC}	0.40 V _{CC}	-20, 70
Reset voltage, V	V _{RST}		2.0	0.4	1.0	25±10
			18.0			
			2.0	0.2	1.5	-20, 70
			18.0			
Control Voltage Lead, V	V _{CV}			0.65 V _{CC}	0.69 V _{CC}	25±10
				0.60 V _{CC}	0.80 V _{CC}	-20, 70
Output voltage Low, V	V _{OL}	I _{OL} = 3.2 mA	5.0		0.4	25±10
		I _{OL} = 20 mA	15.0		1.0	
		I _{OL} = 3.2 mA	5.0		0.6	-20, 70
		I _{OL} = 20 mA	15.0		1.5	
Output voltage High, V	V _{OH}	I _{OH} = -0.8 mA	5.0	4.0		25±10
			15.0	14.3		
			5.0	3.5		-20, 70
			15.0	14.0		
Supply Current, µA	I _{CC}		2.0		200	25±10
			18.0		300	
			2.0		400	-20, 70
			18.0		600	

AC ELECTRICAL CHARACTERISTICS

Parameter, unit	Symbol	Test Conditions		Value		Temperature, °C
		R _L , C _L	V _{CC} , V	Min	Max	
Rise (Fall) Time of Output, ns	t _{THL} , t _{TLH}	R _L = 10 MΩ, C _L = 10 pF	5.0	35	75	25±10
				70	150	-20, 70
Guaranteed Max Osc Freq, kHz	f _{MAX}	Astable Operation	2.0-18.0	500		25±10
				200		-20, 70
Initial accuracy, %				5		
Drift with Temperature, %/°C	αf	R _L = 1 - 100 kΩ, C _L = 0.1 μF	5.0		0.02	-20, 70
					0.03	
					0.06	
Drift with Supply Voltage, %/B	Δf		5.0		3	25±10
					6	-20, 70



Figura 1. Block Diagram



Figura 2. Switching Waveforms

**N SUFFIX PLASTIC DIP
(MS – 001BA)**

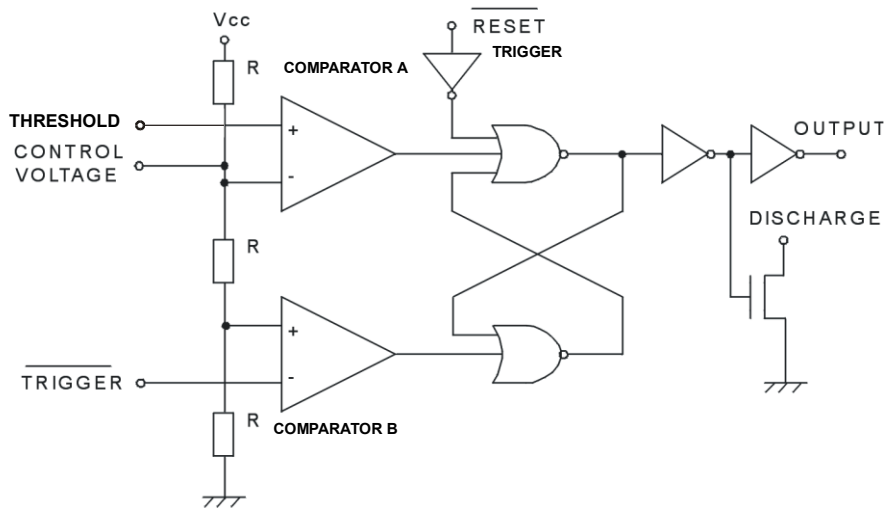

$\oplus 0.25 (0.010) \text{M} \text{T}$

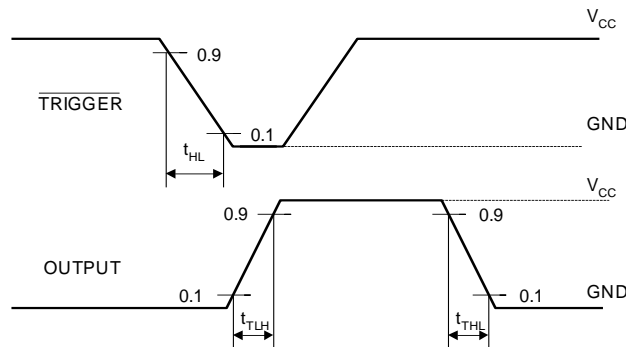
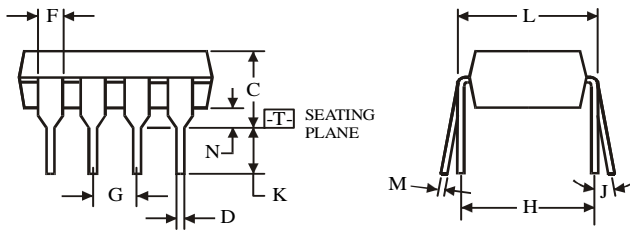
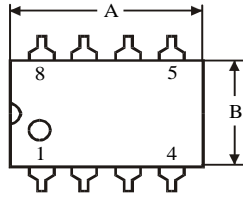
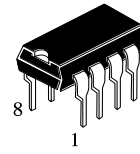
Symbol	Dimension, mm	
	MIN	MAX
A	8.51	10.16
B	6.1	7.11
C		5.33
D	0.36	0.56
F	1.14	1.78
G	2.54	
H	7.62	
J	0°	10°
K	2.92	3.81
L	7.62	8.26
M	0.2	0.36
N	0.38	

NOTES:

- Dimensions “A”, “B” do not include mold flash or protrusions.
Maximum mold flash or protrusions 0.25 mm (0.010) per side.

**D SUFFIX SOIC
(MS - 012AA)**

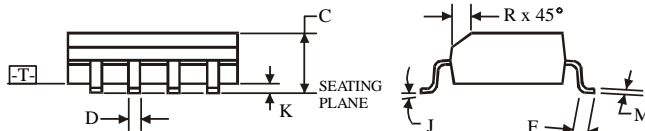
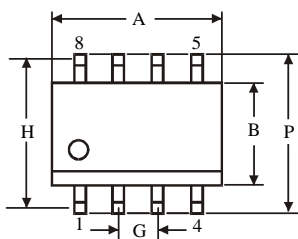
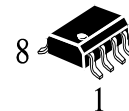

$\oplus 0.25 (0.010) \text{M} \text{T} \text{C} \text{M}$

Symbol	Dimension, mm	
	MIN	MAX
A	4.8	5
B	3.8	4
C	1.35	1.75
D	0.33	0.51
F	0.4	1.27
G	1.27	
H	5.72	
J	0°	8°
K	0.1	0.25
M	0.19	0.25
P	5.8	6.2
R	0.25	0.5

NOTES:

- Dimensions A and B do not include mold flash or protrusion.
- Maximum mold flash or protrusion 0.15 mm (0.006) per side for A; for B - 0.25 mm (0.010) per side.