

5-V/100mA Low Power Low-Drop Fixed-Voltage Regulator with low current consumption

ILE4264-2G

The ILE 4264-2G is a Monolithic Integrated Low Power Low-Drop Fixed Voltage Regulator 5-V/100mA with low current consumption. The ILE 4264-2G is specially designed to create power source with 5V output voltage, loads up to 100 mA and drop voltage less than 0.5V. The regulator is designed to supply electronic device in automotive applications and some another applications. The ILE 4264-2G is equipped with additional protection against overvoltage of both polarities, load current limitation, short-circuit and over temperature shutdown of output voltage.

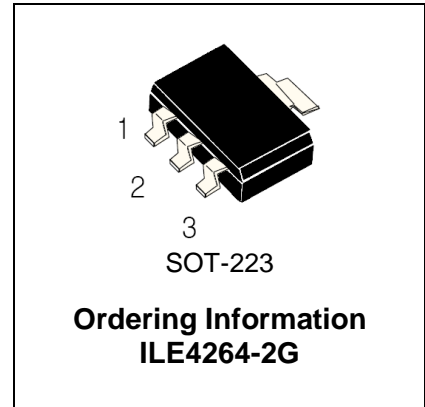

ORDERING INFORMATION

Device	Operating Temperature Range	Package	Packing
ILE4264-2G	T _J = -40°C to 125°C	SOT-223	T&R

Features

- Output voltage tolerance 5V ±3% (±2% up to 50 mA)
- Low-drop voltage
- Current capability up to 150 mA
- Very low current consumption
- Over temperature protection
- Reverse polarity proof
- Suitable for use in automotive electronics
- Short-circuit proof
- Low quiescent current of 60μA
- AEC-Q100 Qualified
- ESD Protection : HBM ±8.000V / MM ±400V / CDM ±2.000V

Block Diagram

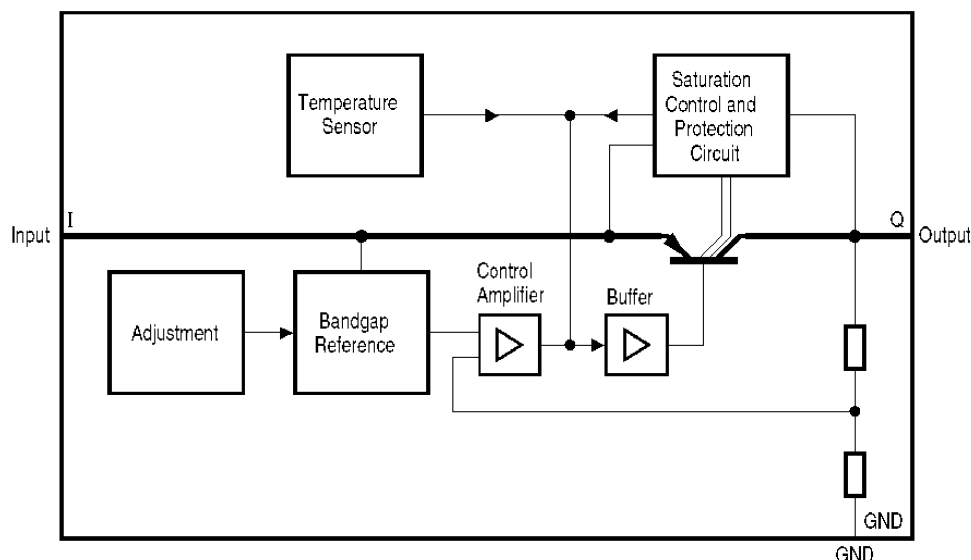

Pin Description (for SOT-223 package)

Pin	Symbol	Function
01	I	Input voltage; block to ground directly with a ceramic capacitor
03	Q	5-V output voltage; block to ground with a capacitor ($C_a \geq 10 \mu F$, $ESR \leq 4\Omega$)
02, 04	GND	Ground

Absolute Maximum Ratings

Parameter	Symbol	Min	Max	Unit	Note
Input voltage	V_I	-42	45	V	
Input current	I_I				limited internally
Ground pin current	I_{GND}	50	-	mA	
Output voltage	V_Q	-0.3	32	V	
Output current	I_Q				limited internally
Junction temperature	T_J	-40	150	°C	
Storage temperature	T_{stg}	-50	150	°C	

* Stresses beyond those listed under “absolute maximum ratings” may cause permanent damage to the device. These are stress ratings only and functional operation of the device at these or any other conditions beyond those indicated under “recommended operating conditions” is not implied. Exposure to absolute-maximum-rated conditions for extended periods may affect device reliability.

Operating Range

Parameter	Symbol	Min	Max	Unit
Input voltage	V_I	6	28	V
Junction temperature	T_J	-40	125	°C

Thermal Resistances

Parameter	Symbol	Min	Max	Unit
Thermal Resistances Junction-case , for conventional case P-SOT223-4-1	$R_{th\ jc}$	-	25*	°C/W
Thermal Resistances Junction-ambient, for conventional case P-SOT223-4-1, - without heat sink	$R_{th\ ja}$	-	220*	°C/W

* $R_{th\ ja}$ - Thermal Resistances Junction-ambient

Thermal resistance junction ambient for IC with heat dissipater is calculated by formula:

$$R_{th\ ja} = R_{th\ jc} + R_{th\ ca} \tag{1}$$

$R_{th\ jc}$ - thermal resistance junction case, °C /W.

Application circuit and heat dissipater have to provide $T_J \leq 125^\circ C$.

Maximum power P_{tot} , W, dissipated by IC for T_A , is calculated by formula:

$$P_{tot} = (125 - T_A) / R_{th\ ja} \tag{2}$$

125 – maximum permitable operating junction temperature, °C

Electrical Characteristics

($V_I=13.5\text{ V}$, $-40^\circ\text{C} \leq T_J \leq 125^\circ\text{C}$, unless specified otherwise)

Parameter	Symbol	Test Conditions	Limit Value			Unit	Note
			Min	Typ	Max		
Output voltage	V_Q	$9\text{V} \leq V_I \leq 16\text{V}$ $5\text{mA} \leq I_Q \leq 50\text{mA}$	4.9	5.0	5.1	V	
		$6\text{V} \leq V_I \leq 21\text{V}$ $5\text{mA} \leq I_Q \leq 100\text{mA}$	4.85	5.0	5.15		
Output current limiting	I_Q		150		500	mA	²
Current consumption $I_q = I_I - I_Q$	I_q	$I_Q=0.1\text{mA}$, ($T_J \leq 85^\circ\text{C}$)	-		0.06	mA	
		$I_Q = 0.1\text{mA}$	-		0.07		
		$I_Q = 50\text{mA}$	-		4		
Drop-out voltage	V_{Dr}	$I_Q = 100\text{mA}$	-	0.25	0.5	V	¹
Load regulation	$\Delta V_{Q(I)}$	$1\text{ mA} \leq I_Q \leq 100\text{ mA}$ $V_I = 13.5\text{ V}$	-		90	mV	
Line regulation	$\Delta V_{Q(V)}$	$6\text{V} \leq V_I \leq 28\text{V}$ $I_Q = 1\text{mA}$	-		30	mV	

Note:

¹ Drop voltage $V_{Dr} = V_I - V_Q$ (measured when the output voltage V_Q has dropped 100mV from the nominal value obtained at $V_I = 13.5\text{V}$).

² Limiting current is output current when output voltage out from $4.8\text{V} \leq V_Q \leq 5.2\text{V}$ range.

Typical Performance Parameters

($V_I=13.5\text{ V}$, $-40^\circ\text{C} \leq T_J \leq 125^\circ\text{C}$, unless specified otherwise)

Parameter	Symbol	Test Condition	Typical Value	Unit
Power Supply Ripple Rejection	PSRR	$f_r = 100\text{ Hz}$, $V_r = 3\text{ V}$ (peek-to-peek)	68	dB

Application Circuit

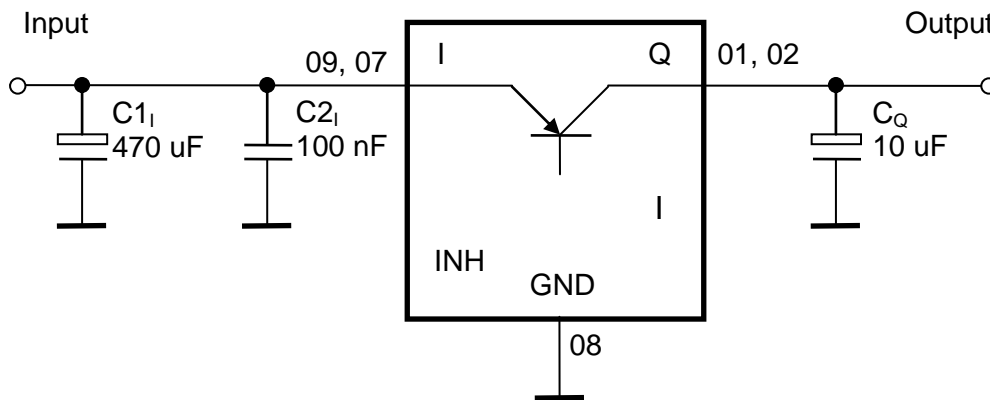

In the ILE4264-2G the output voltage is divided and compared to an internal reference of 2.5V typical. The regulation loop controls the output to achieve an output voltage of 5V with an accuracy of $\pm 3\%$ at an input voltage range of $5.5V < V_i < 45V$.

Figure shows a typical application circuit. For stability of the control loop the ILE4264-2G output requires an output capacitor C_Q of at least $10\mu F$ with a maximum permissible ESR of 4Ω . Tantalum as well as multi layer ceramic capacitors are suitable.

At the input of the regulator an input capacitor is necessary for compensating line influences ($100nF$ ceramic capacitor recommended). A resistor of approx. 1Ω in series with C_i can damp any oscillation occurring due the input inductivity and the input capacitor.

In the application circuit shown in Figure an additional electrolytic input capacitor of $470\mu F$ is added in order to buffer supply line influences. This capacitor is recommended, if the device is sourced via long supply lines of several meters.

The ILE4264-2G can supply current up to 150mA. However for protection for high input voltage above 25V, the output current is reduced (SOA protection).

Typical Performance Characteristics

Output Voltage V_O versus Temperature T_j

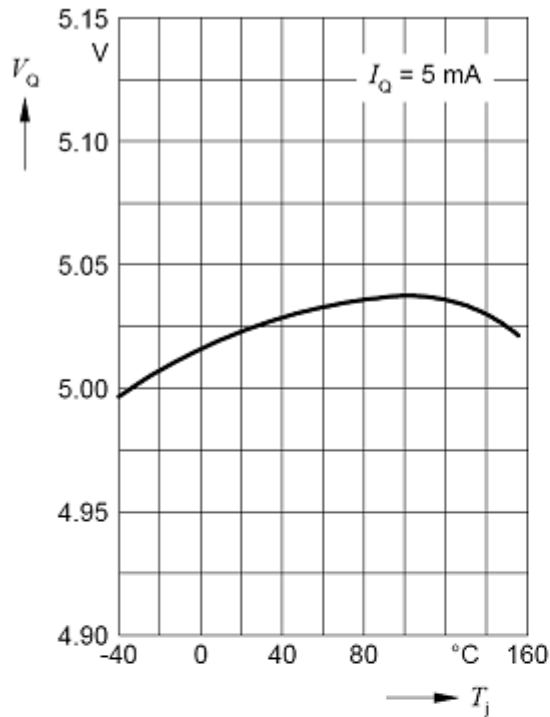

Drop Voltage V_{dr} versus Output Current I_O

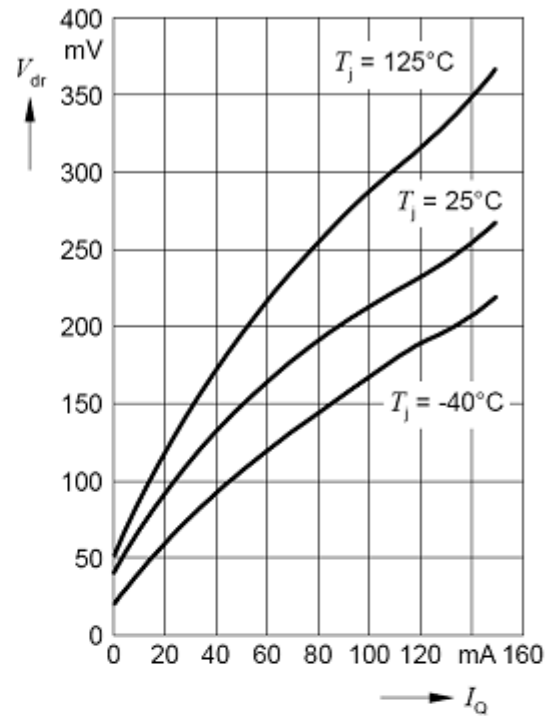

Output Voltage V_O versus Input Voltage V_I

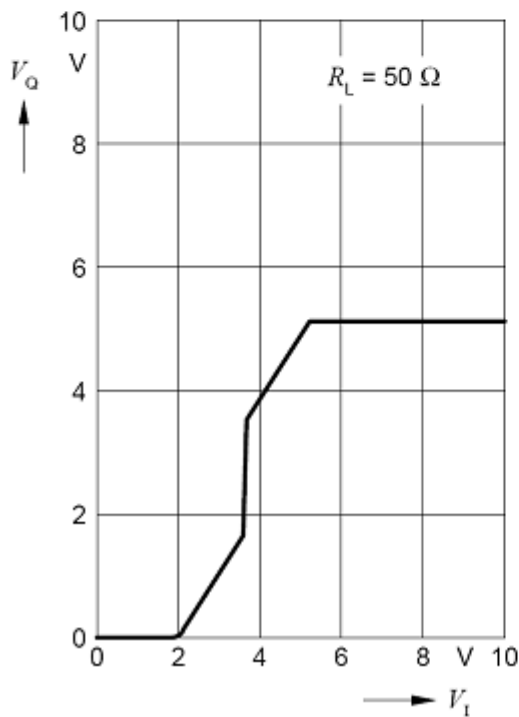

Typical Performance Characteristics

(continue)

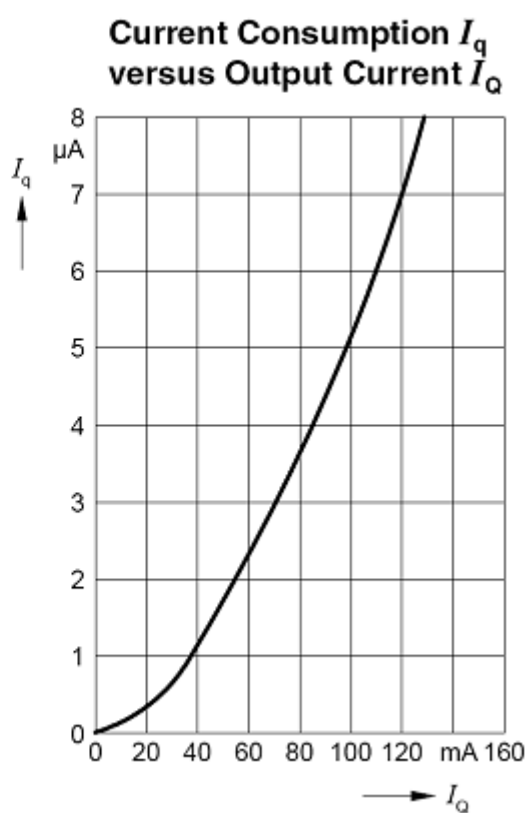
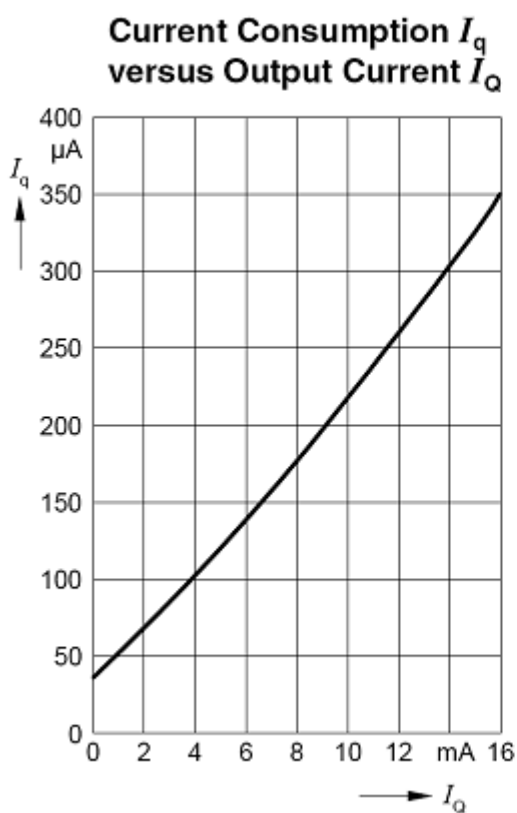

Package Dimensions

SOT- 223

