

# Hex Inverter Buffers/Drivers with Open-Collector High-Voltage Outputs

**IN7406**

The IN7406 monolithic TTL hex inverter buffers/drivers feature high-voltage open collector outputs for interfacing with high-level circuits (such as MOS) or for driving high-current loads (such as lamps or relays), and are also characterized for use as inverter buffers for driving TTL inputs.

- Minimum breakdown Voltages is 30 V
- Maximum sink Current is 40 mA
- Converts TTL Voltage Levels to MOS Levels
- Open-Collector Driver for Indicator Lamps and Relays
- Inputs Fully Compatible with MOST TTL Circuits.

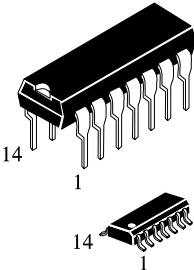

N SUFFIX  
PLASTIC

D SUFFIX  
SOIC

**ORDERING INFORMATION**

IN7406N Plastic  
IN7406D SOIC

T<sub>A</sub> = -10° to 70° C for all packages

## LOGIC DIAGRAM

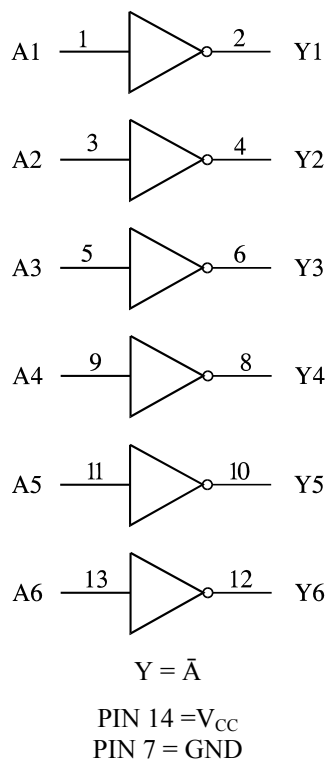

## PIN ASSIGNMENT

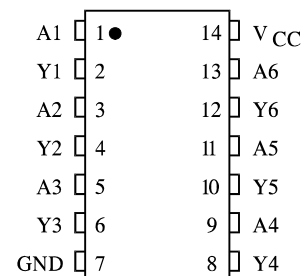

## FUNCTION TABLE

Inputs	Output
A	Y
L	Z
H	L

Z = High Impedance

**MAXIMUM RATINGS\***

Symbol	Parameter	Value	Unit
V <sub>CC</sub>	Supply Voltage	7.0	V
V <sub>IN</sub>	Input Voltage	5.5	V
V <sub>OUT</sub>	Output Voltage	30	V
T <sub>stg</sub>	Storage Temperature Range	-65 to +150	°C

\*Maximum Ratings are those values beyond which damage to the device may occur. Functional operation should be restricted to the Recommended Operating Conditions.

**RECOMMENDED OPERATING CONDITIONS**

Symbol	Parameter	Min	Max	Unit
V <sub>CC</sub>	Supply Voltage	4.75	5.25	V
V <sub>IH</sub>	High Level Input Voltage	2.0		V
V <sub>IL</sub>	Low Level Input Voltage		0.8	V
U <sub>OH</sub>	High Level Output Voltage		30	V
I <sub>OL</sub>	Low Level Output Current		40	mA
T <sub>A</sub>	Ambient Temperature Range	-10	+70	°C

**DC ELECTRICAL CHARACTERISTICS**

Symbol	Parameter	Test Conditions	Guaranteed Limit		Unit
			Min	Max	
V <sub>IK</sub>	Input Clamp Voltage	V <sub>CC</sub> = 4.75V, I <sub>IN</sub> = -12 mA		-1.5	V
I <sub>OH</sub>	High Level Output Current	V <sub>CC</sub> = 4.75V, V <sub>OH</sub> = 30V		0.25	mA
V <sub>OL</sub>	Low Level Output Voltage	V <sub>CC</sub> = 4.75V, I <sub>OL</sub> = 16 mA		0.4	V
		V <sub>CC</sub> = 4.75V, I <sub>OL</sub> = 40 mA		0.7	
I <sub>IH</sub>	High Level Input Current	V <sub>CC</sub> = 5.25V, V <sub>IN</sub> = 2.4 V		0.04	mA
I <sub>IL</sub>	Low Level Input Current	V <sub>CC</sub> = 5.25V, V <sub>IN</sub> = 0.4 V		-1.6	mA
I <sub>CC</sub>	Supply Current	V <sub>CC</sub> = 5.25V	Outputs High	48	mA
			Outputs Low	51	

**AC ELECTRICAL CHARACTERISTICS** ( $T = 25^{\circ}\text{C}$ ,  $V_{CC} = 5.0\text{ V}$ ,  $C_L = 15\text{ pF}$ ,  
 $R_L = 110\ \Omega$ , Input  $t_r = t_f = 10\text{ ns}$ )

Symbol	Parameter	Min	Max	Unit
$t_{PLH}$	Propagation Delay Time, Low to High Level Output (from Input to Output)		18	ns
$t_{PHL}$	Propagation Delay Time, High to Low Level Output (from Input to Output)		28	ns

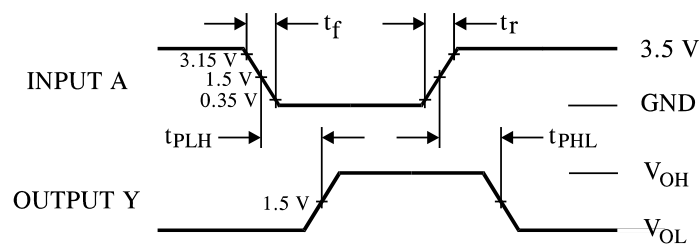

**Figure 1. Switching Waveforms**

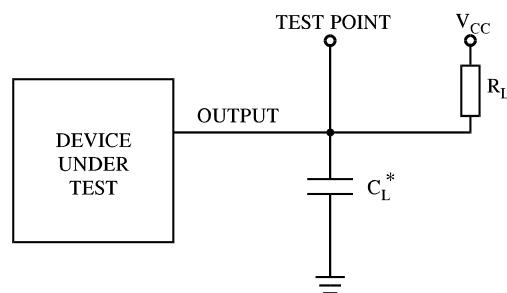

\* Includes all probe and jig capacitance

**Figure 2. Test Circuit**

**N SUFFIX PLASTIC DIP  
(MS - 001AA)**

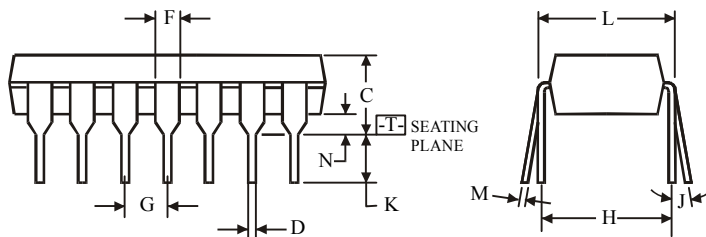
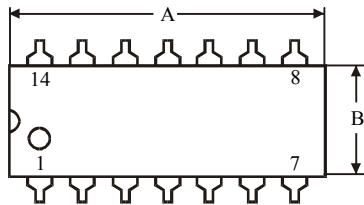
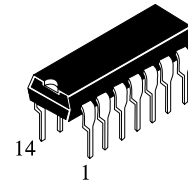

$\oplus 0.25 (0.010) \text{ (M) T}$

**NOTES:**

- Dimensions "A", "B" do not include mold flash or protrusions.  
Maximum mold flash or protrusions 0.25 mm (0.010) per side.

Symbol	Dimension, mm	
	MIN	MAX
A	18.67	19.69
B	6.1	7.11
C		5.33
D	0.36	0.56
F	1.14	1.78
G	2.54	
H	7.62	
J	0°	10°
K	2.92	3.81
L	7.62	8.26
M	0.2	0.36
N	0.38	

**D SUFFIX SOIC  
(MS - 012AB)**

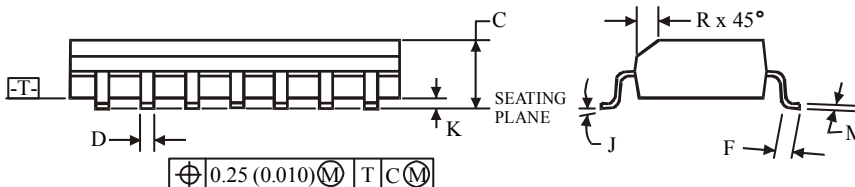
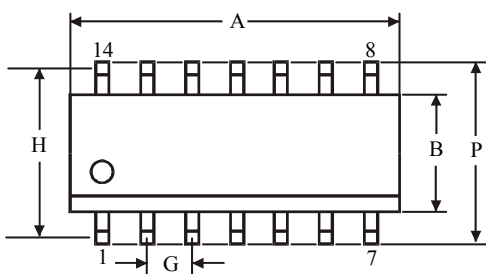
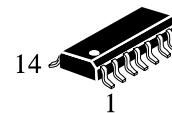

$\oplus 0.25 (0.010) \text{ (M) T C (M)}$

**NOTES:**

- Dimensions A and B do not include mold flash or protrusion.
- Maximum mold flash or protrusion 0.15 mm (0.006) per side for A; for B - 0.25 mm (0.010) per side.

Symbol	Dimension, mm	
	MIN	MAX
A	8.55	8.75
B	3.8	4
C	1.35	1.75
D	0.33	0.51
F	0.4	1.27
G	1.27	
H	5.27	
J	0°	8°
K	0.1	0.25
M	0.19	0.25
P	5.8	6.2
R	0.25	0.5