

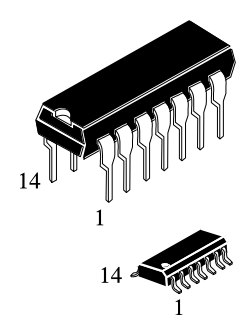
# Quad Single Supply Comparator

**IL339**

The IL339 consists of four independent precision voltage comparators with an offset voltage specification as low as 2.0 mV max for four comparators which were designed specifically to operate from a single power supply over a wide range of voltages.

Application areas include limit comparators, simple analog to digital converters; pulse, squarewave and time delay generators; wide range VCO; MOS clock timers; multivibrators and high voltage digital logic gates.

- Single or Split Supply Operation
- Low Input Bias Current
- Low Input Offset Current
- Input Common Mode Voltage Range to Gnd
- Low Output Saturation Voltage
- TTL and CMOS Compatible

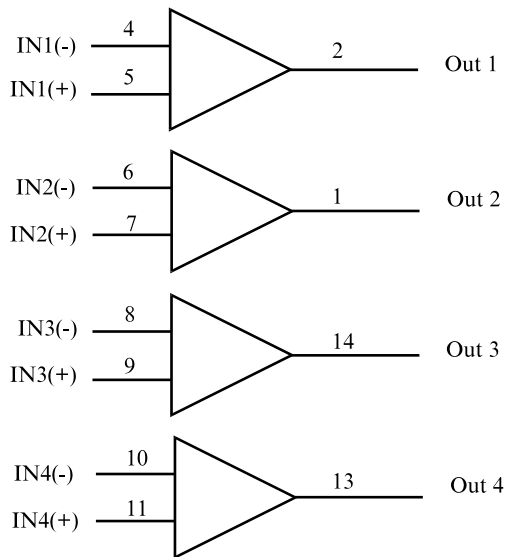


N SUFFIX  
PLASTIC

D SUFFIX  
SOIC

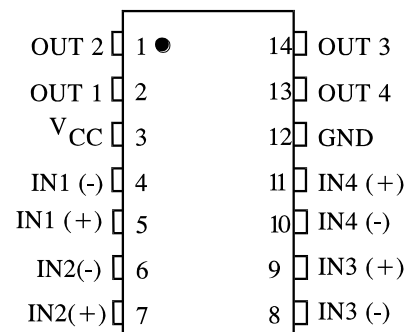
**ORDERING INFORMATION**  
 IL339N Plastic  
 IL339D SOIC  
 $T_A = -40^\circ$  to  $85^\circ$  C for all packages.

## LOGIC DIAGRAM



PIN 3 =  $V_{CC}$   
 PIN 12 = GND

## PIN ASSIGNMENT



**MAXIMUM RATINGS\***

Symbol	Parameter	Value	Unit
$V_{CC}$	Power Supply Voltages		
	Single Supply Split Supplies	36 $\pm 18$	V
$V_{IDR}$	Input Differential Voltage Range	36	V
$V_{ICR}$	Input Common Mode Voltage Range (1)	-0.3 to $V_{CC}$	V
$I_{SC}$	Output Short Circuit to Ground	Continuous	
$I_{IN}$	Input Current, per pin (2)	50	mA
$T_J$	Junction Temperature		
	Plastic Packages	150	$^{\circ}\text{C}$
$T_{stg}$	Storage Temperature	-65 to +150	$^{\circ}\text{C}$
$T_L$	Lead Temperature, 1mm from Case for 10 Seconds	260	$^{\circ}\text{C}$
$P_D$	Power Dissipation @ $T_A=25^{\circ}\text{C}$		
	Plastic Package	1.0	W
	Derate above $25^{\circ}\text{C}$	8.0	mW/ $^{\circ}\text{C}$

\* Stresses beyond those listed under "absolute maximum ratings" may cause permanent damage to the device. These are stress ratings only and functional operation of the device at these or any other conditions beyond those indicated under "recommended operating conditions" is not implied.

Exposure to absolute-maximum-rated conditions for extended periods may affect device reliability.

Functional operation should be restricted to the Recommended Operating Conditions.

Notes:

1. Split Power Supplies.

2.  $V_{IN} < -0.3\text{V}$ . This input current will only exist when voltage at any of the input leads is driven negative.

**RECOMMENDED OPERATING CONDITIONS**

Symbol	Parameter	Min	Max	Unit
$V_{CC}$	DC Supply Voltage	$\pm 2.5$ or 5.0	$\pm 15$ or 30	V
$T_A$	Operating Temperature, All Package Types	-40	+85	$^{\circ}\text{C}$

This device contains protection circuitry to guard against damage due to high static voltages or electric fields. However, precautions must be taken to avoid applications of any voltage higher than maximum rated voltages to this high-impedance circuit. For proper operation,  $V_{IN}$  and  $V_{OUT}$  should be constrained to the range  $\text{GND} \leq (V_{IN} \text{ or } V_{OUT}) \leq V_{CC}$ .

Unused inputs must always be tied to an appropriate logic voltage level (e.g., either GND or  $V_{CC}$ ). Unused outputs must be left open.

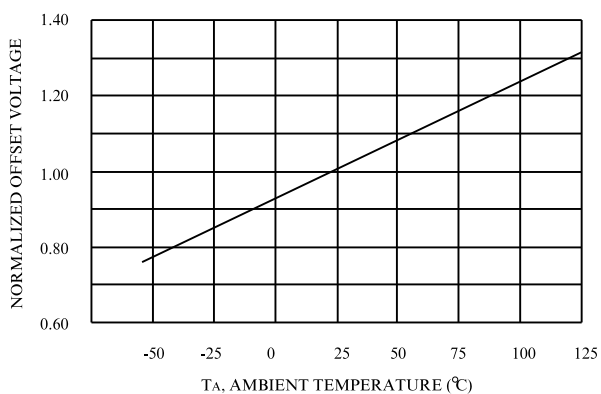
**DC ELECTRICAL CHARACTERISTICS** ( $T_A=-40$  to  $+85^\circ\text{C}$ )

Symbol	Parameter	Test Conditions	Guaranteed Limit			Unit
			Min	Typ	Max	
$V_{IO}$	Input Offset Voltage	$V_0=1.4\text{V}$ $V_{CC}=5.0\text{-}30\text{V}; R_S \leq 100\Omega$ $V_{ICR}=0\text{V} - (V_{CC}-1.5)\text{V}$	-		9.0 5.0*	mV
$I_{IB}$	Input Bias Current	$V_0=1.4\text{V}$ $V_{CC}=5.0\text{-}30\text{V}$ $V_{ICR}=0\text{V} - (V_{CC}-1.5)\text{V}$	-		400	nA
$I_{IO}$	Input Offset Current	$V_0=1.4\text{V}$ $V_{CC}=5.0\text{-}30\text{V}$ $V_{ICR}=0\text{V} - (V_{CC}-1.5)\text{V}$	-		$\pm 150$	nA
$V_{ICR}$	Input Common Mode Voltage Range	$V_{CC}=5.0\text{-}30\text{V}$	0		$V_{CC}-2.0\text{V}$	V
$I_{CC}$	Supply Current	$R_L=\infty, V_{CC}=5.0$ $R_L=\infty, V_{CC}=30\text{V}$	- -		2.0* 2.5*	mA
$A_{VOL}$	Voltage Gain	$V_{CC}=15\text{V}, R_L=15\text{K}\Omega$	-	200*	-	V/mV
$t_1$	Large Signal Response Time	$V_{IN}=\text{TTL Logic Swing}$ , $V_{ref}=1.4\text{V}, V_{CC}=5.0\text{V}$ , $R_L=5.1\text{K}\Omega, V_{RL}=5.0\text{V}$	-	300*	-	ns
$t_2$	Response Time	$V_{CC}=5.0\text{V}, R_L=5.1\text{K}\Omega$ , $V_{RL}=5.0\text{V}$	-	1.3*	-	$\mu\text{s}$
$I_{sink}$	Output Sink Current	$V_{I(-)}=1.0\text{V}, V_{I(+)}=0\text{V}$ , $V_0 \leq 1.5\text{V}, V_{CC}=5.0\text{V}$	6.0*	-	-	mA
$V_{sat}$	Saturation Voltage	$V_{I(-)}=1.0\text{V}, V_{I(+)}=0\text{V}$ , $I_{sink} \leq 4.0\text{mA}, V_{CC}=5.0\text{V}$	-	-	700	mV
$I_{OL}$	Output Leakage Current	$V_{I(+)}=1.0\text{V}, V_{I(-)}=0\text{V}$ , $V_0=5.0\text{V}$ $V_0=30\text{V}$		0.1*	1000	nA
$V_{IDR}$	Differential Input Voltage Range	All $V_{IN} \geq \text{GND}$ or $V\text{-Supply}$ (if used)			$V_{CC}^*$	V

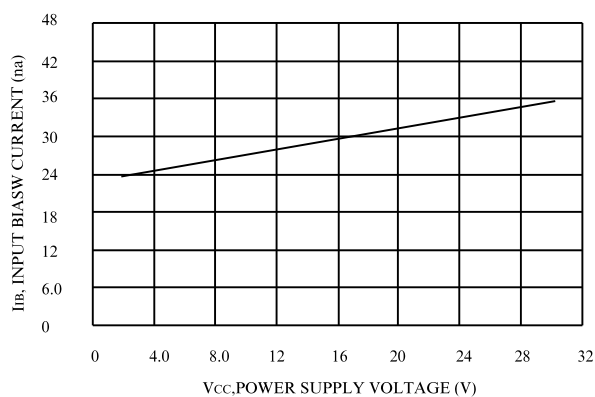
\*=@25°C

**TYPICAL PERFORMANCE CHARACTERISTICS**

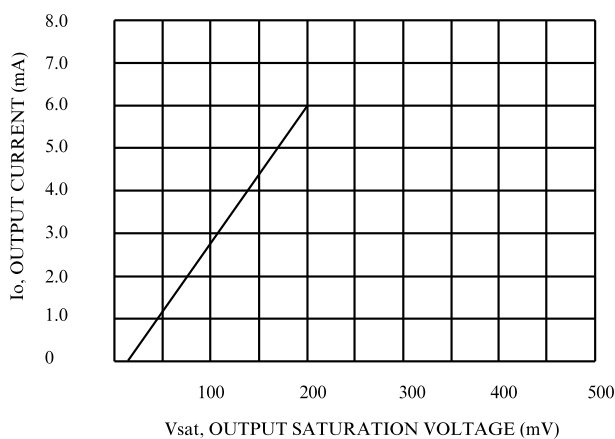
( $V_{CC}=1.5V$ ,  $T_A=+25^{\circ}C$ , (each comparator))



**Figure 1. Normalized Input Offset Voltage**

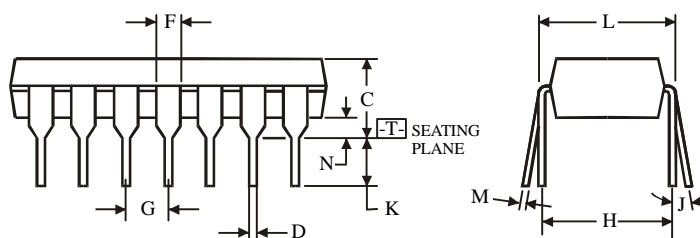
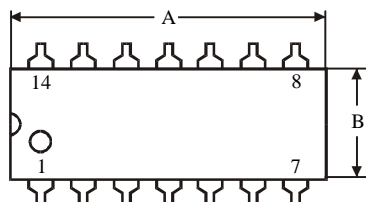
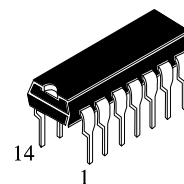


**Figure 2. Input Bias Current**



**Figure 3. Output Sink Current versus Output Saturation Voltage**

**N SUFFIX PLASTIC DIP  
(MS - 001AA)**



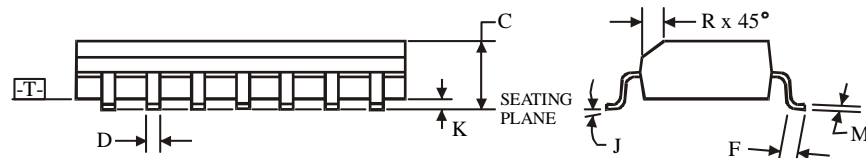
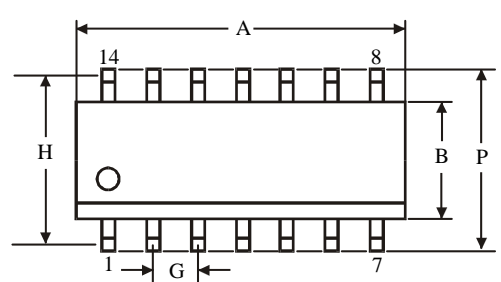
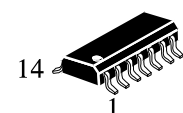
$\oplus 0.25 (0.010) \text{ (M) T}$

**NOTES:**

- Dimensions "A", "B" do not include mold flash or protrusions.  
Maximum mold flash or protrusions 0.25 mm (0.010) per side.

Symbol	Dimension, mm	
	MIN	MAX
A	18.67	19.69
B	6.1	7.11
C		5.33
D	0.36	0.56
F	1.14	1.78
G	2.54	
H	7.62	
J	0°	10°
K	2.92	3.81
L	7.62	8.26
M	0.2	0.36
N	0.38	

**D SUFFIX SOIC  
(MS - 012AB)**



$\oplus 0.25 (0.010) \text{ (M) T C (M)}$

**NOTES:**

- Dimensions A and B do not include mold flash or protrusion.
- Maximum mold flash or protrusion 0.15 mm (0.006) per side for A; for B - 0.25 mm (0.010) per side.

Symbol	Dimension, mm	
	MIN	MAX
A	8.55	8.75
B	3.8	4
C	1.35	1.75
D	0.33	0.51
F	0.4	1.27
G	1.27	
H	5.27	
J	0°	8°
K	0.1	0.25
M	0.19	0.25
P	5.8	6.2
R	0.25	0.5